



# INSTALLATION INSTRUCTIONS

Accessory  
**REAR SEAT COVER**  
P/N 08P32-TX4-200

Application  
**2014 RDX**

Publications No.  
**BII 51221**  
Issue Date  
**MARCH 2014**

Put this information in the glove box with the vehicle owner's manual.

## PARTS LIST

Left rear seat back cover

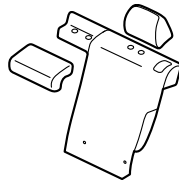

Right rear seat back cover



Armrest cover

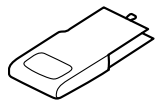

Seat cushion cover

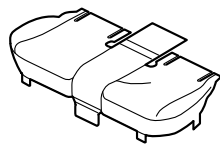

Bag

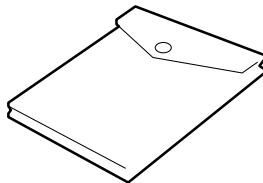

## INSTALLATION

### Installing the Headrest Covers

1. Remove each rear seat headrest by pushing on the headrest guide knob and pulling up the headrest.

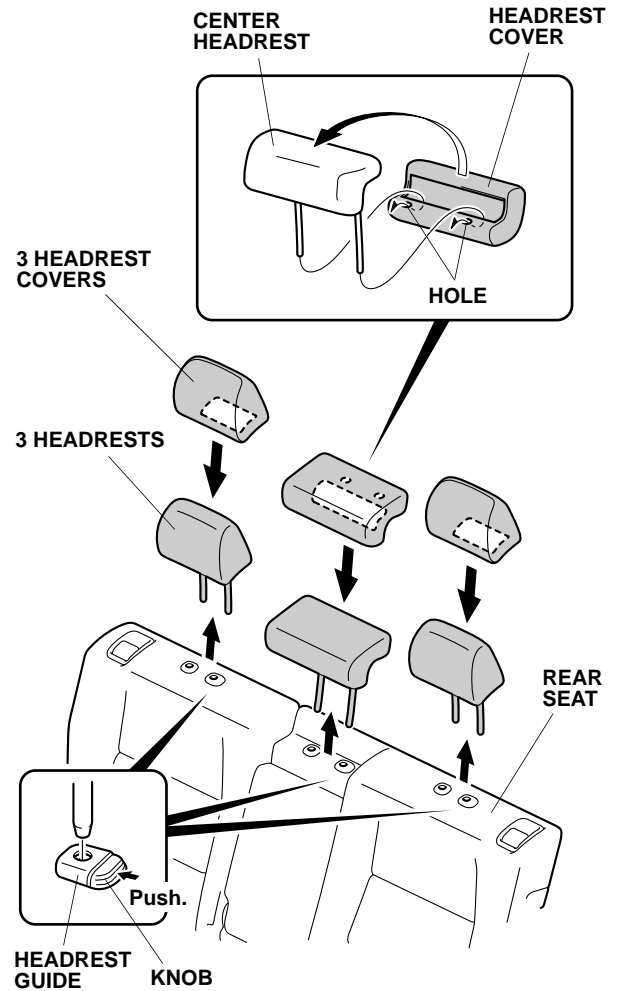

2. Fit a headrest cover over each headrest.

### Installing the Left Rear Seat Back Cover

3. Fold down the armrest. Install the left rear seat back cover to the left rear seat back. Insert the left rear seat back cover under the headrest guides. Secure the fasteners to the left rear seat back. If the vehicle is equipped with an accessory cargo liner, secure the back fastener to the fastener on the cargo liner.

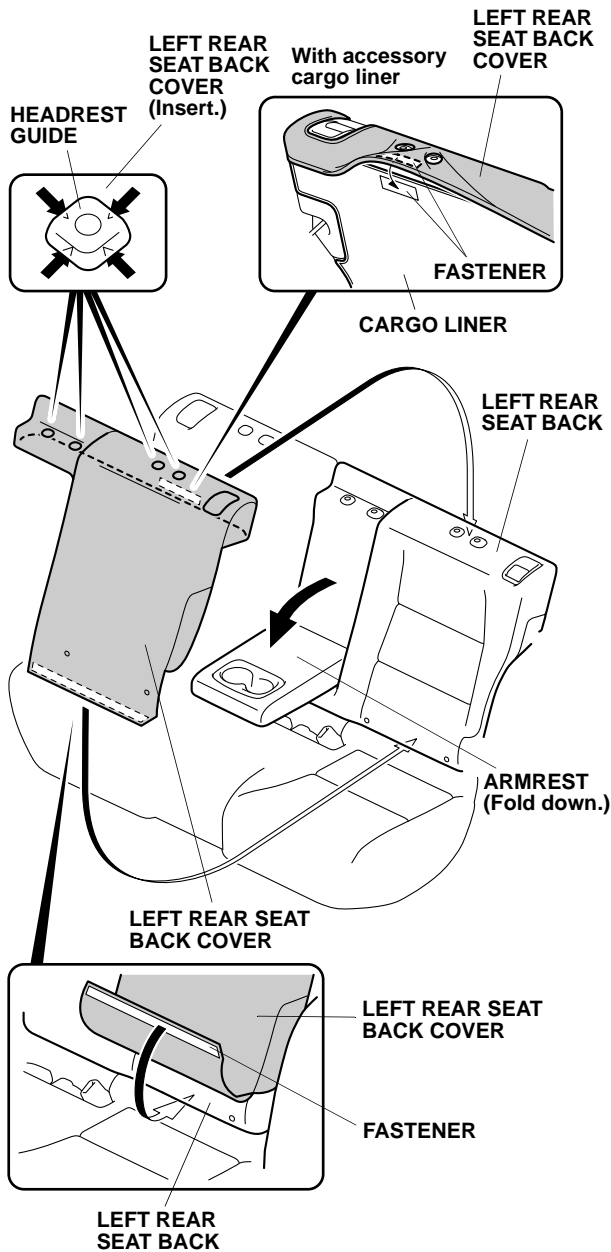

### Installing the Armrest Cover

4. Install the armrest cover over the armrest.

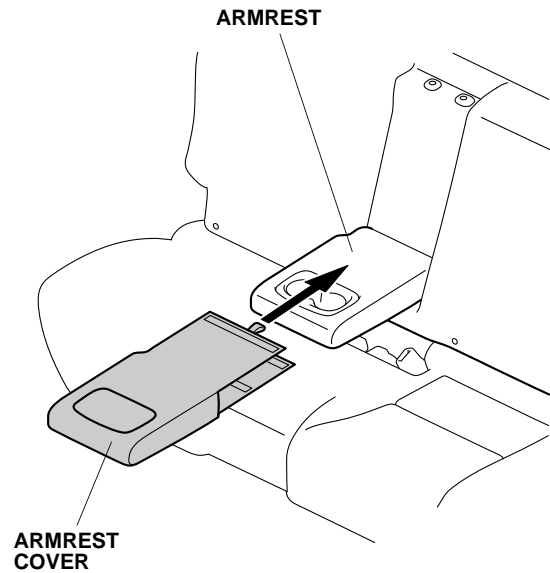

5. Raise the armrest. Pull the armrest cover between the armrest and left rear seat back, and secure the fasteners on the armrest cover as shown.

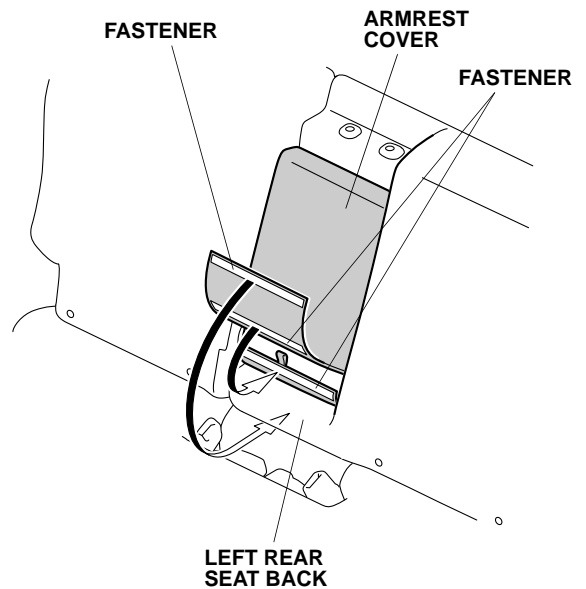

6. Secure the fastener to the bottom of the left rear seat back.

## Installing the Right Rear Seat Back Cover

7. Install the right rear seat back cover to the right rear seat back. Insert the right rear seat back cover under the headrest guides. Secure the fasteners to the right rear seat back. If the vehicle is equipped with an accessory cargo liner, secure the back fastener to the fastener on the cargo liner.

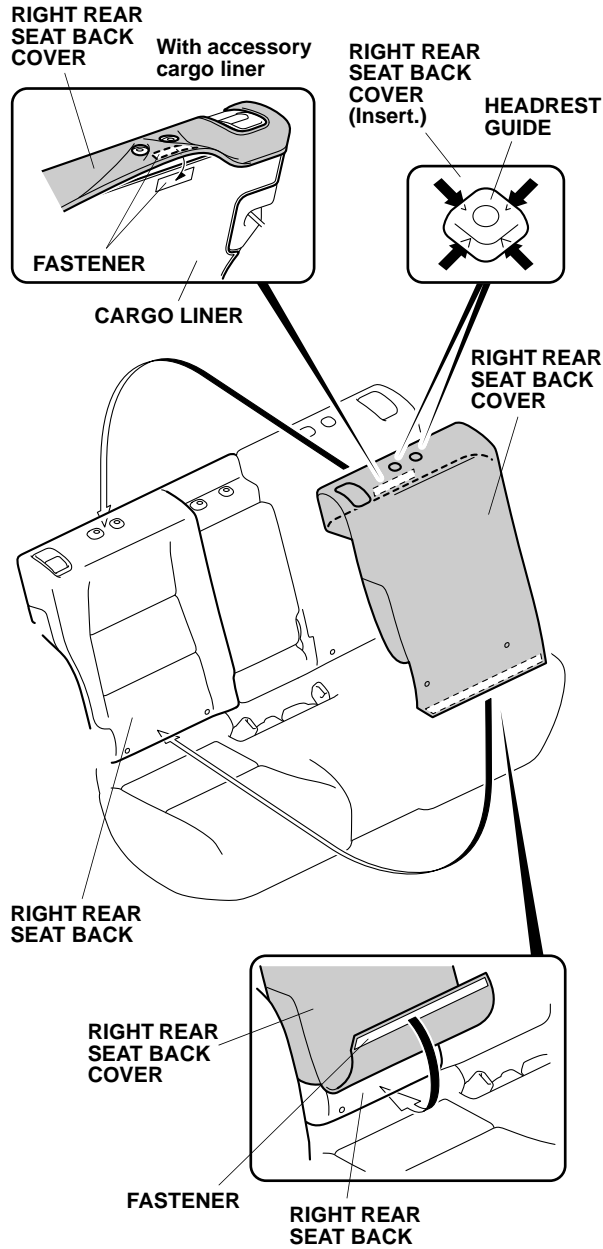

## Installing the Seat Cushion Cover

8. Install the seat cushion cover over the rear seat cushion. Insert three tabs under the rear seat cushion. Secure the fasteners to the rear seat cushion.

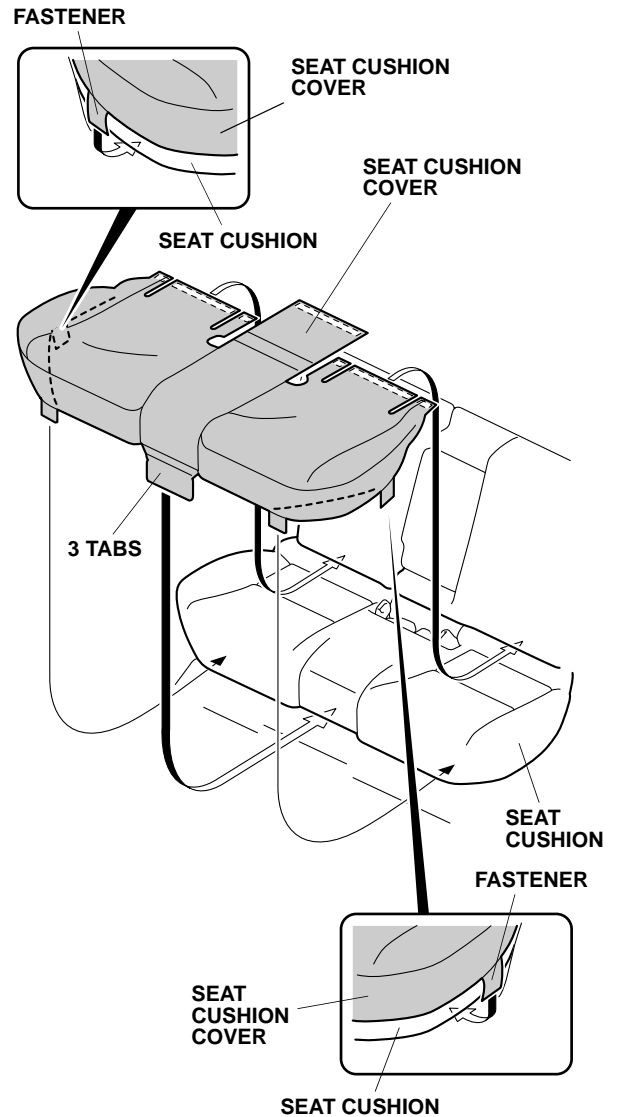

9. Put the seat cushion cover around the center seat belt buckles as shown. Insert the seat cushion cover between the rear seat back and the rear seat cushion, and secure the fasteners to the rear seat cushion.

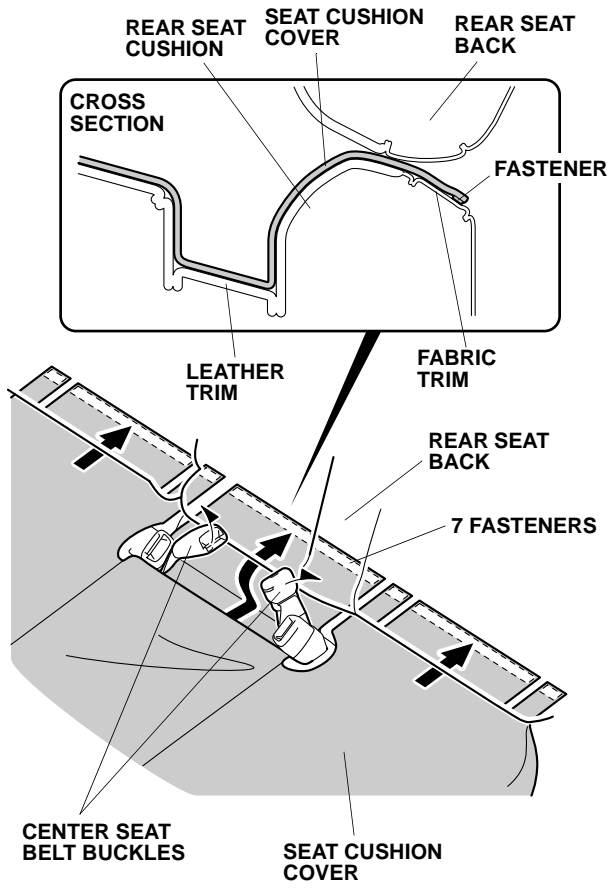

10. Reinstall the headrests.