



INSTALLATION INSTRUCTIONS

Accessory
CARGO LINER
P/N 08P42-TX4-200

Application
2015 RDX

Publications No.
BII 51211
Issue Date
MARCH 2014

Put this information in the glove box with the vehicle owner's manual.

PARTS LIST

Cargo liner

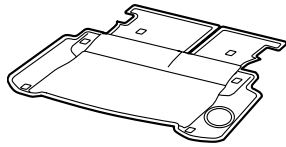

Bag

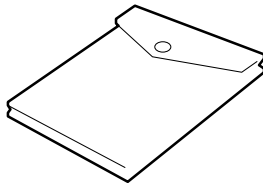

INSTALLATION

1. Pull the lever on each rear seat back and fold the seat back forward.

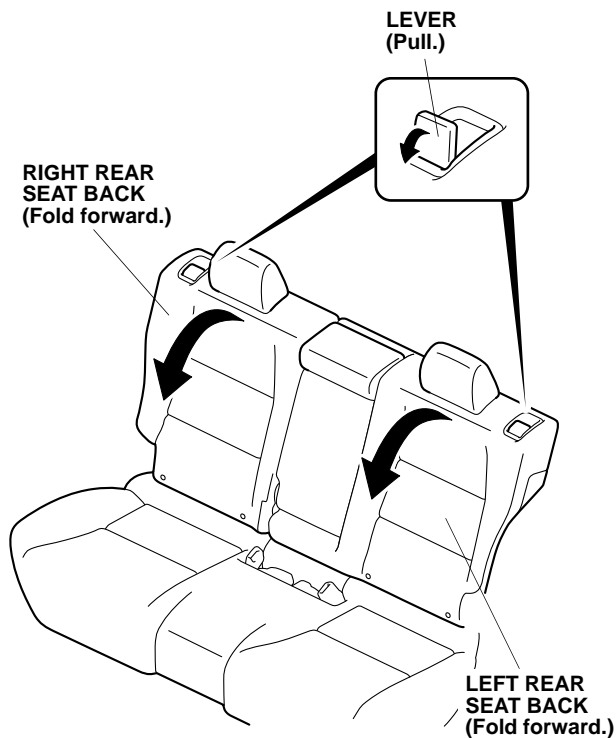

2. Open the tailgate. Position the cargo liner in the cargo area. Secure the cargo liner to the cargo area floor with the fasteners.

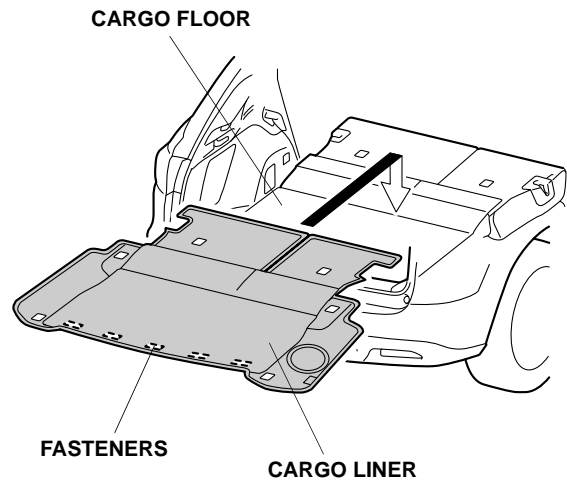

3. Secure the cargo liner to the left rear side trim with the fasteners.

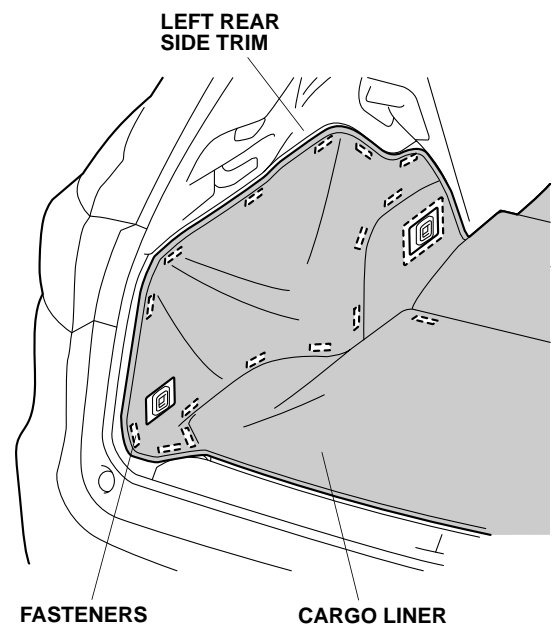

4. Secure the cargo liner to the right rear side trim.

5. Insert the left floor flap into the pocket in the cargo liner.

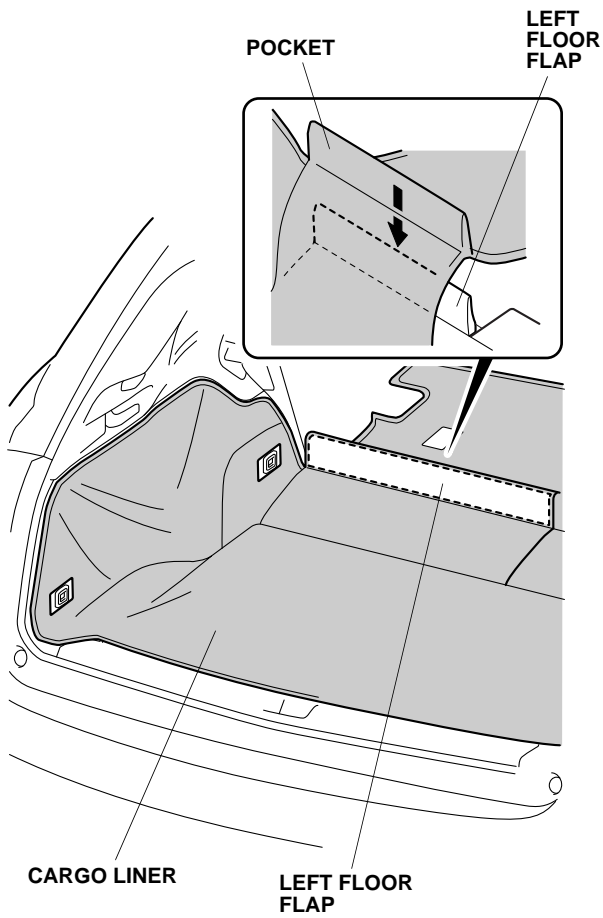

6. Secure the cargo liner to the left rear seat back with the fasteners. If the vehicle is equipped with a rear seat cover, release one fastener, fasten the cargo liner to the seat-back, then secure the seat cover to the cargo liner.

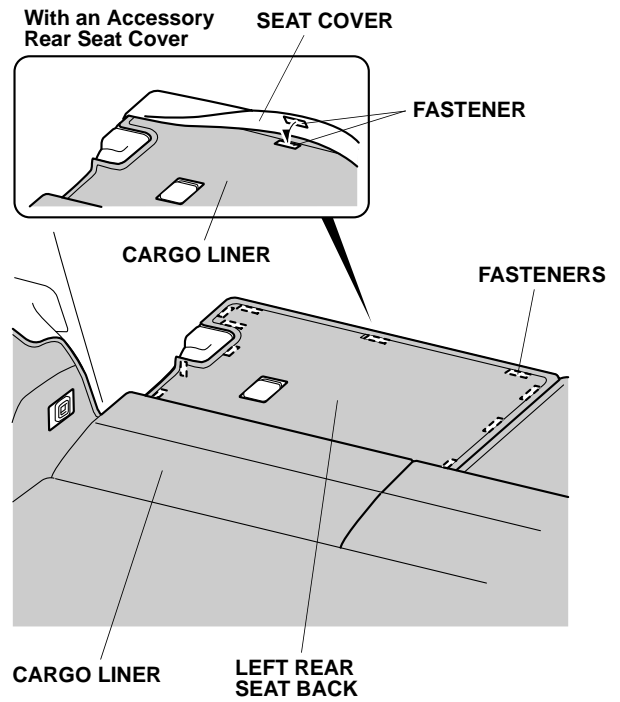

7. Repeat steps 5 and 6 to secure the right side of the cargo liner.