



INSTALLATION INSTRUCTIONS

Accessory
BODY SIDE MOLDING

Application
2015 RDX

Publications No.
BII 51209
Issue Date
MARCH 2014

PARTS LIST

Left front body side molding

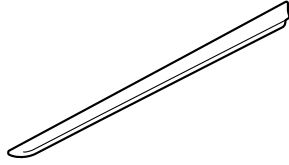

Right front body side molding

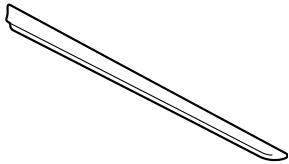

Left rear body side molding

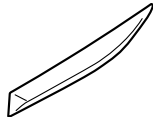

Right rear body side molding

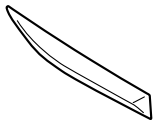

4 Alcohol swabs

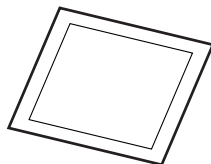

Template

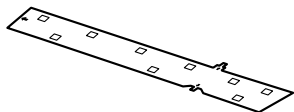

TOOLS AND SUPPLIES REQUIRED

Masking tape

Ruler

The following tool is available through the Honda Tool and Equipment Program. On the iN, click on: Service > Service Bay > Tool and Equipment Program, then enter the number under "Search". Or, call 888-424-6857.

Rubber roller (T/N MHLE54D)

Illustration of the Body Side Moldings on the Vehicle

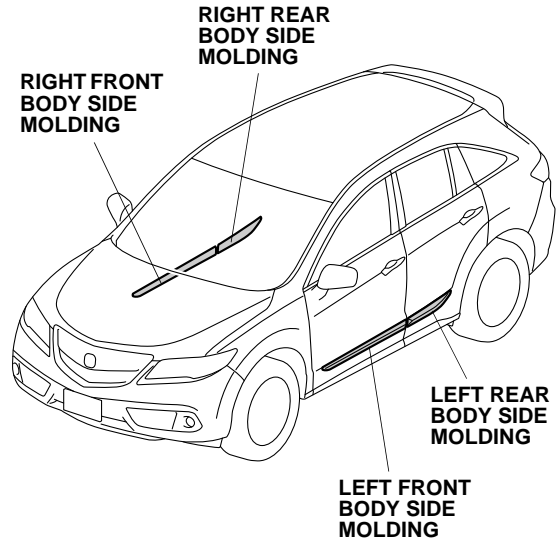

INSTALLATION

Client Information: The information in this installation instruction is intended for use only by skilled technicians who have the proper tools, equipment, and training to correctly and safely add equipment to your vehicle. These procedures should not be attempted by "do-it-yourselfers."

NOTE:

- If you are also installing the accessory door edge film kit (sold separately), install it before you install the body side molding.
- Do not damage the paint finish.
- This kit should be installed only if the ambient air temperature is 15°C (60°F) or above.
- To allow the adhesive to cure, do not wash the vehicle for 24 hours. Please advise the client.

1. Fold the top and bottom tabs located in the center of the template. Insert the folded tabs between the left front door and left rear door.

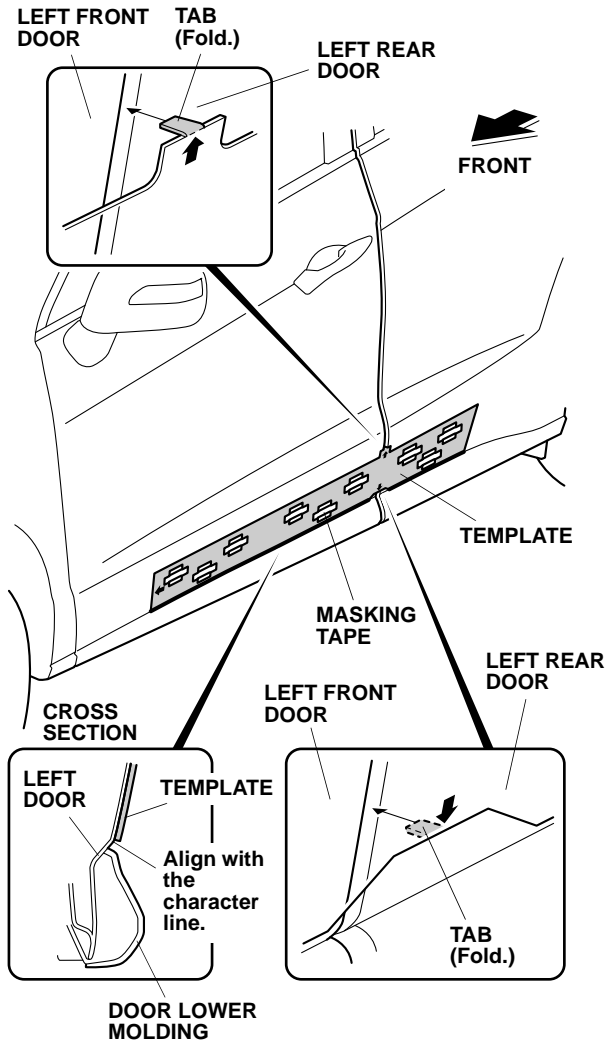

2. Align the template with the character line above the door lower molding, and attach the template to the left doors with strips of masking tape as shown.

3. Using an alcohol swab, thoroughly clean the left front door where the left front body side molding will attach.

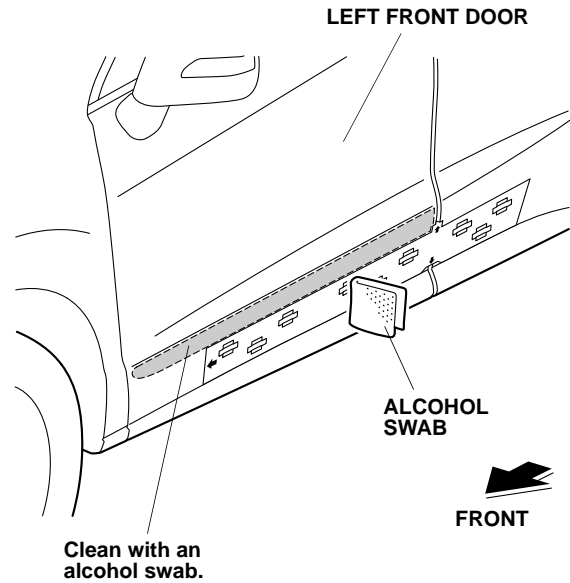

4. Using an alcohol swab, thoroughly clean the left rear door where the left rear body side molding will attach.

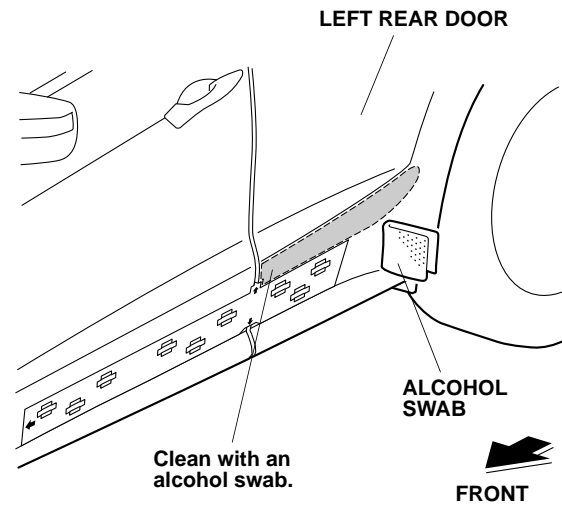

5. Peel back the adhesive backing from two adhesive strips, and tape the ends to the front surface of the body side molding with masking tapes. Remove the small pieces of adhesive backings.

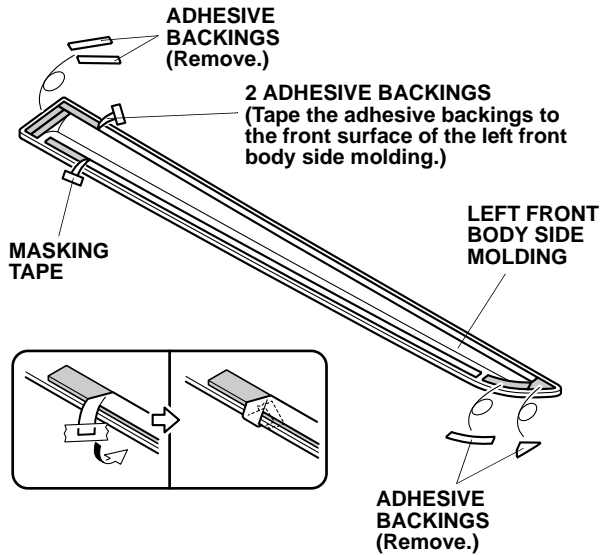

6. Align the left front body side molding with the template and attach it to the left front door as shown. NOTE: If the vehicle is equipped with door edge film, attach the left front body side molding at the indicated position.

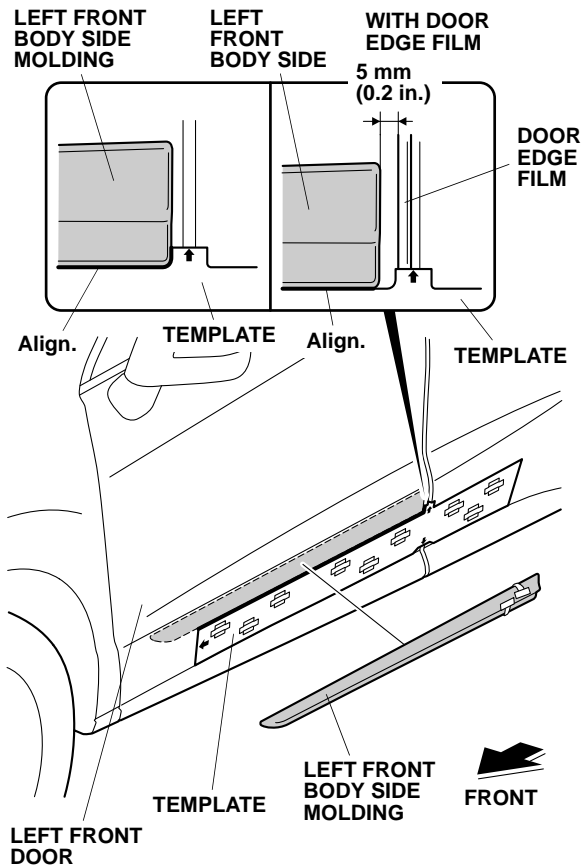

7. While applying light pressure against the left front body side molding, carefully remove the taped adhesive backings.

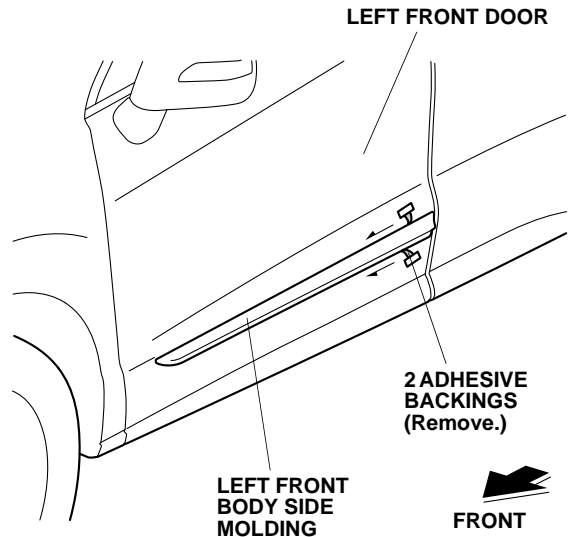

8. Using a rubber roller, apply pressure against the left front body side molding and roll from one end to the other.

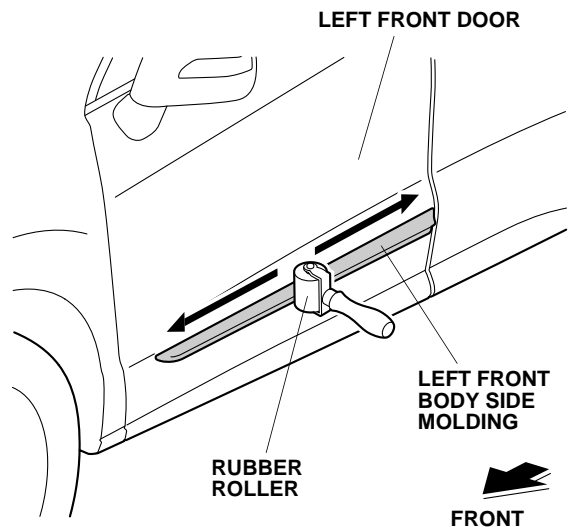

- Peel back the adhesive backing from three adhesive strips, and tape the ends to the front surface of the body side molding. Remove the small pieces of adhesive backing.

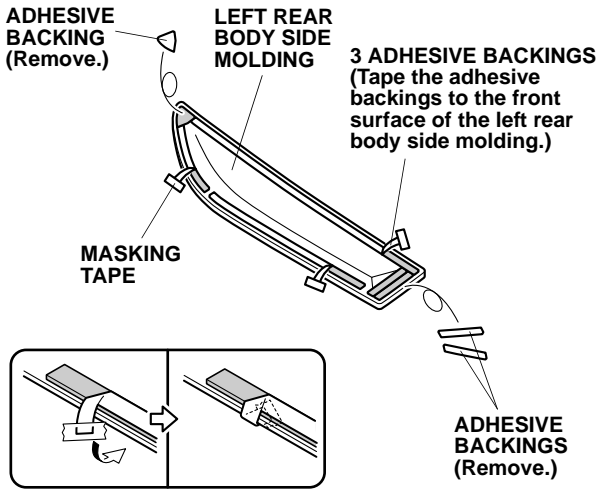

- Align the left rear body side molding with the template and attach it to the left rear door as shown.

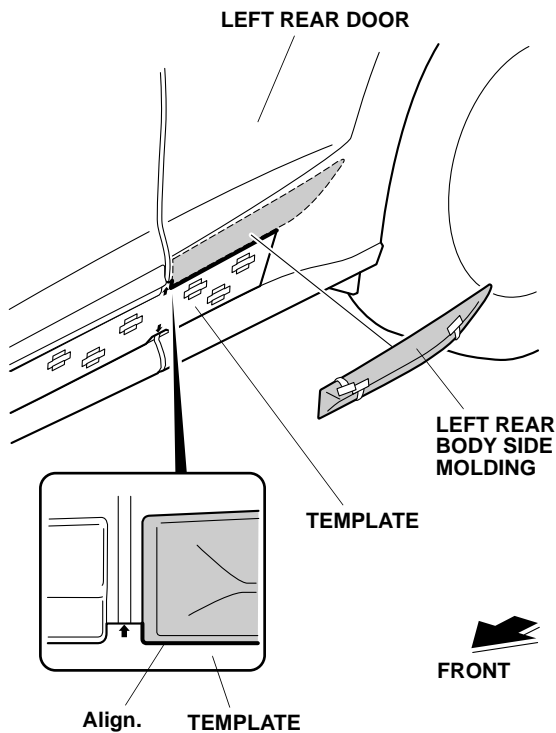

- While applying light pressure against the left rear body side molding, carefully remove the taped adhesive backings.

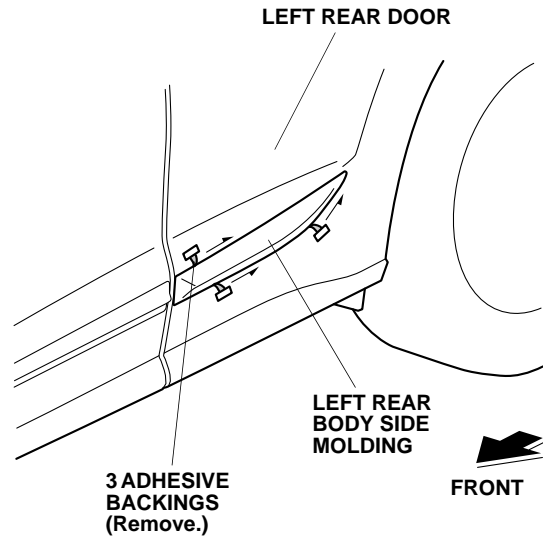

- Using a rubber roller, apply pressure against the left rear body side molding and roll from one end to the other.

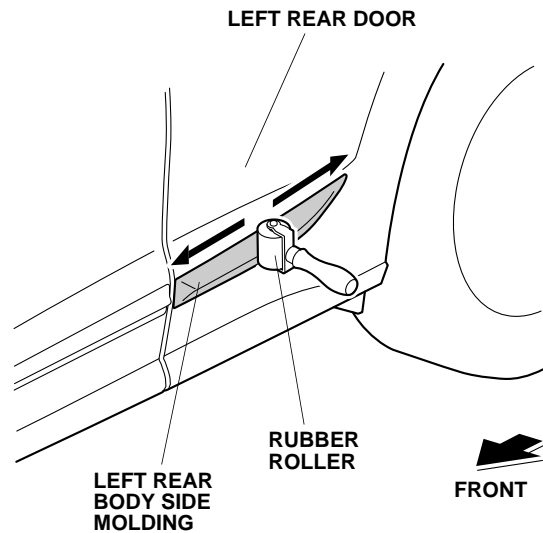

- Turn the template over and repeat steps 1 through 12 to install the body side moldings on the right side of the vehicle.