



INSTALLATION INSTRUCTIONS

Accessory
TRUNK TRAY
P/N 08U45-TK4-200

Application
2014 TL

Publications No.
BII 50172
Issue Date
AUG 2013

PARTS LIST

Trunk tray

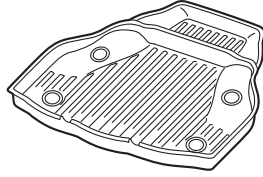

TOOLS AND SUPPLIES REQUIRED

Utility knife

INSTALLATION

1. On AWD models, cut out the marked area on the trunk tray with a utility knife.

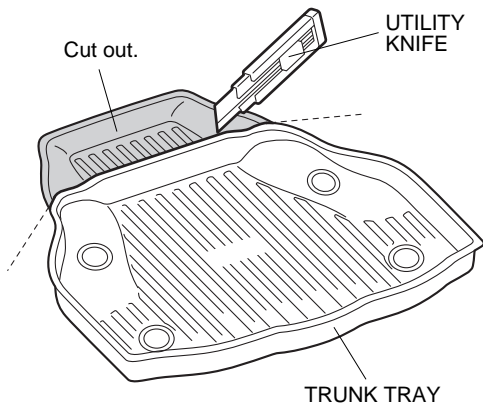

2. If the vehicle is equipped with a cargo net, cut out the four marked areas on the trunk tray with a utility knife.

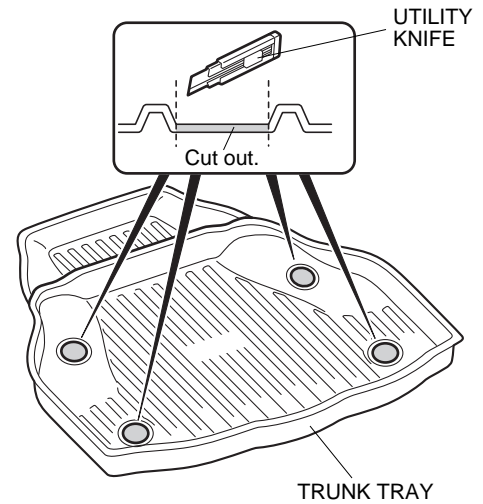

3. Open the trunk lid, and install the trunk tray in the trunk floor.

