

PARTS LIST

Select knob



2 Screws



TOOLS AND SUPPLIES REQUIRED

Phillips screwdriver

Torque screwdriver (T/N; CDI 401 SM)

(Available through the American Honda Tool and Equipment Program; call 888-424-6857)

INSTALLATION

1. Remove the cover, insert the key into the opening, push on the key, and move the shift knob to the S position.

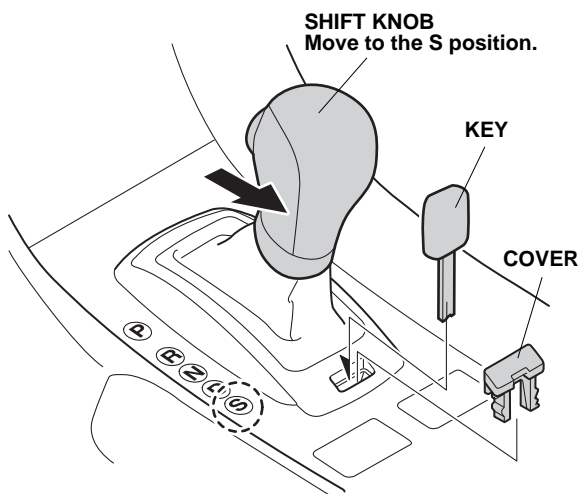

2. Lower the shift boot by pushing the two tabs in the positions shown.

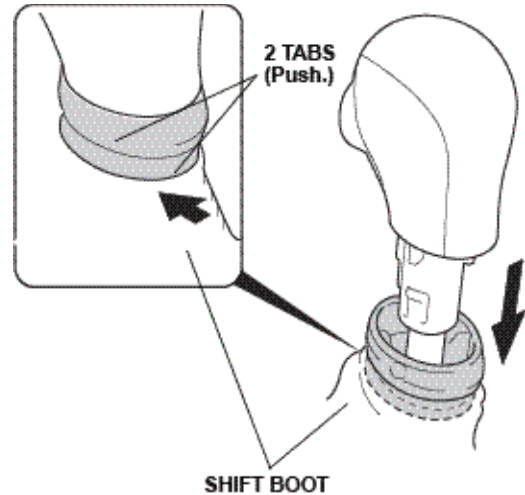

3. Pry out on the bottom of the shift knob cover and remove the cover.

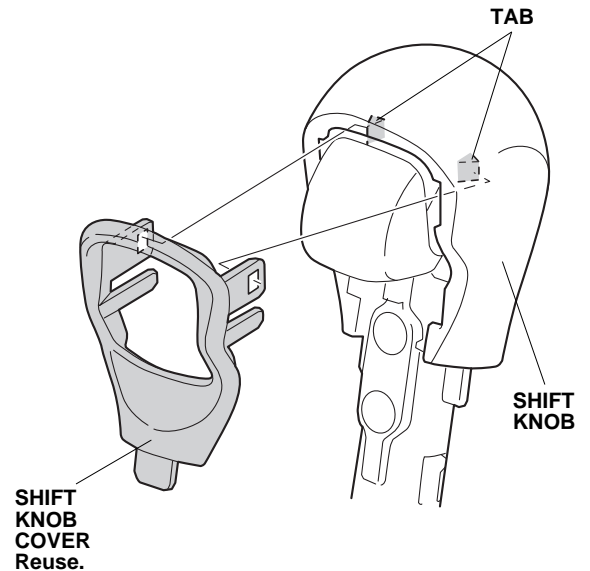

4. Remove and discard the two screws from the shift knob, and remove the shift knob by pulling it up.

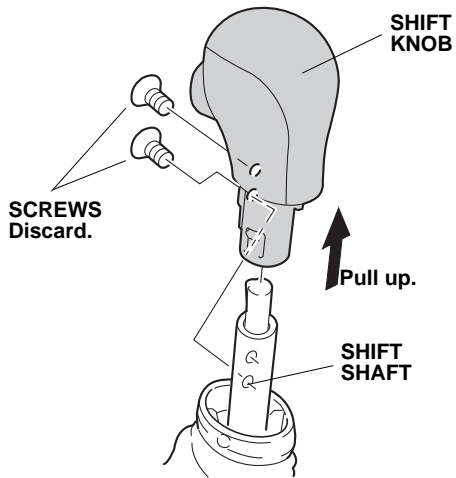

5. Install the new select knob using the two new screws. Using a torque screwdriver, torque the screws to 1.57 N·m (14 lb-in). Do not overtighten the screws.

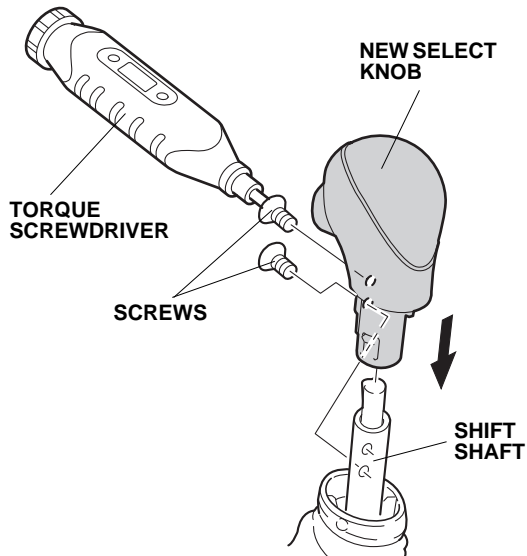

6. Reinstall the shift knob cover on the select knob.

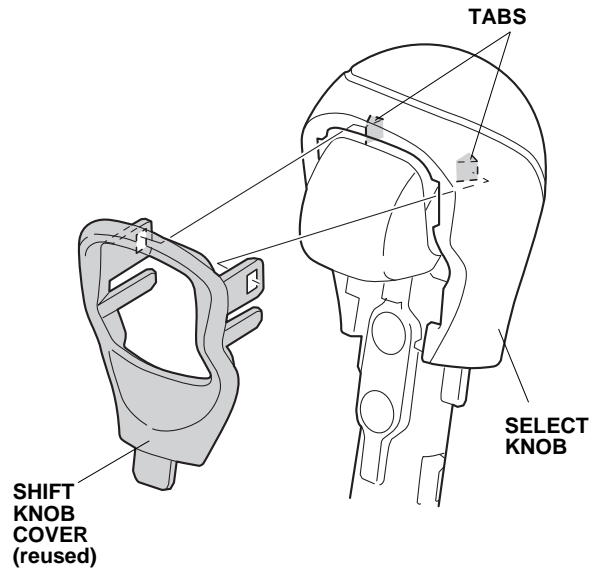

7. Pull the shift boot up to seat it in the normal position.

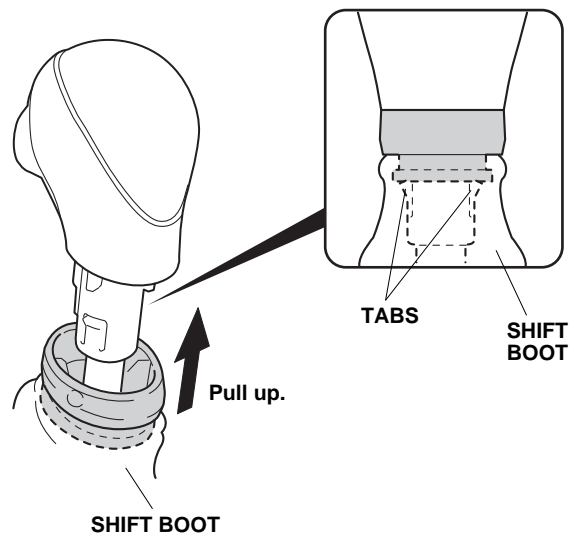

USE AND CARE

- Use a sponge or cloth and a solution of mild liquid dishwashing soap and water to clean the select knob.
- Rinse the knob completely with water, then dry it with a shop towel.
- Never use organic solvents such as benzene, thinner, or gasoline to clean the select knob.