



INSTALLATION INSTRUCTIONS

Accessory
SPLASH GUARDS
P/N 08P00-TX4-200

Application
2014 RDX

Publications No.
BII 48871
Issue Date
MARCH 2013

PARTS LIST

Left front splash guard

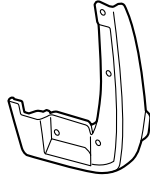

Right front splash guard

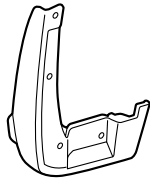

Left rear splash guard

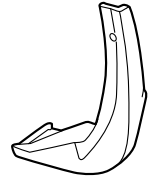

Right rear splash guard

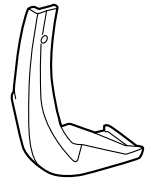

2 Long clips

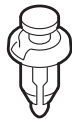

2 Short clips

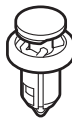

4 Washer-screws



TOOLS AND SUPPLIES REQUIRED

Phillips screwdriver

Stubby phillips screwdriver

Pushpin

Illustration of the Splash Guards on the Vehicle

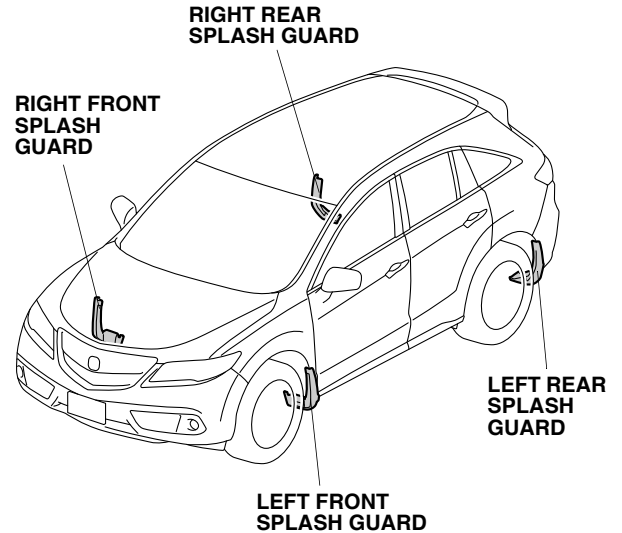

INSTALLATION

Client Information: The information in this installation instruction is intended for use only by skilled technicians who have the proper tools, equipment, and training to correctly and safely add equipment to your vehicle. These procedures should not be attempted by “do-it-yourselfers.”

NOTE:

- Do not to damage the paint finish.
- Clean and wax the areas to be covered with a high-quality paste wax.

Installing the Front Splash Guards

1. Turn the steering wheel fully counterclockwise.
2. Using a pushpin, pierce the centers of two clips in the left front inner fender.

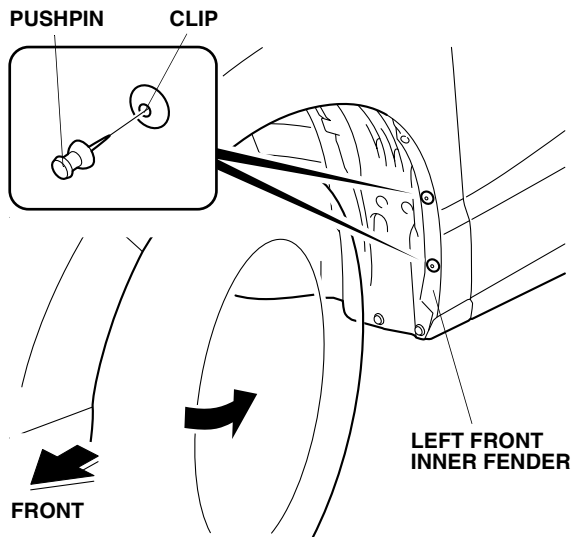

3. Remove two self-tapping screws from the left front inner fenderwell.

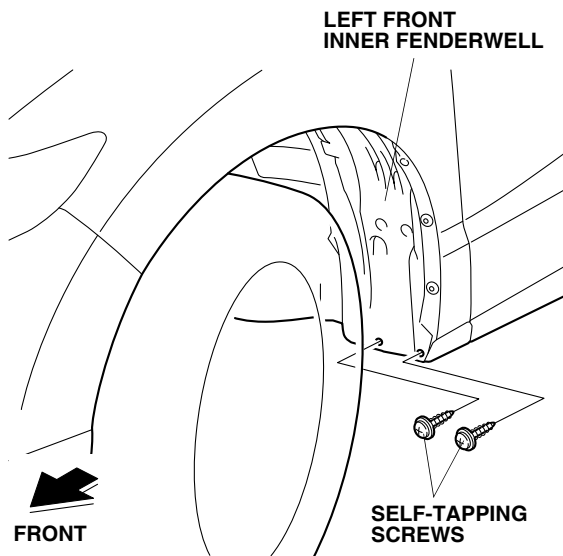

4. Install the left front splash guard to the left front inner fender with two washer-screws and the two self-tapping screws removed in step 3. Tighten in the order 1 → 2 → 3 → 4.

NOTE: Make sure there is no gap between the left front splash guard and the vehicle body. If there is a gap, loosen the washer-screws and self-tapping screws, hold the splash guard against the body, and retighten the screws.

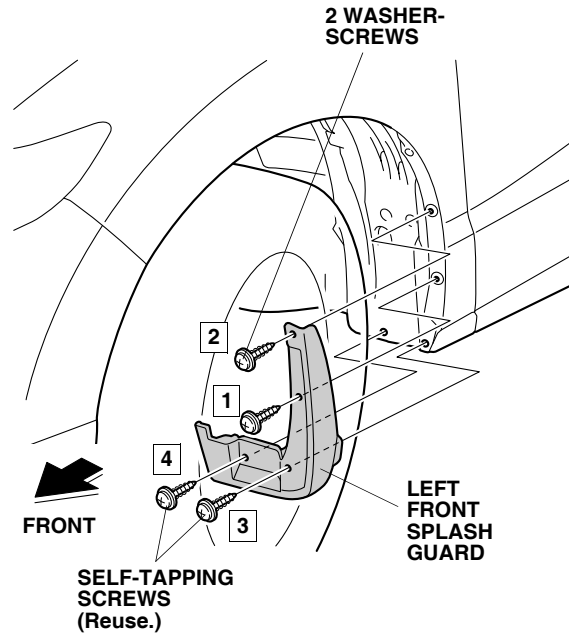

5. Turn the steering wheel fully clockwise, and repeat steps 2 through 4 to install the right front splash guard.

Installing the Rear Splash Guards

6. Remove the self-tapping screw from the rear bumper.

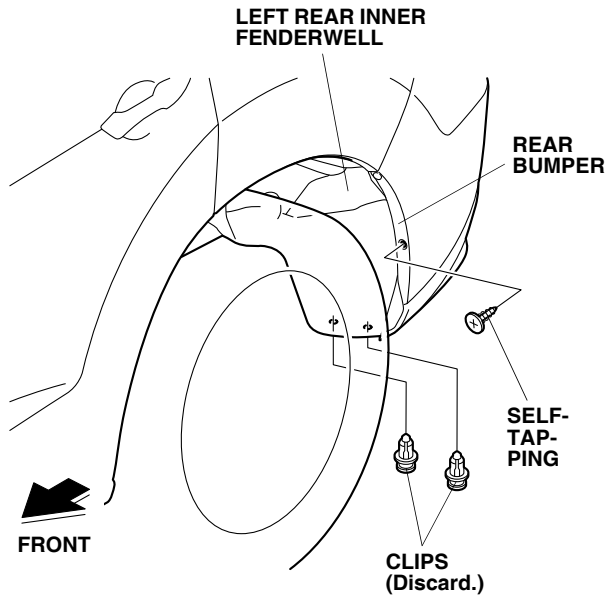

7. Remove and discard the two clips from the left rear inner fenderwell.

8. Install the left rear splash guard to the rear bumper with one long clip, one short clip and the self-tapping screw removed in step 6. Install in the order **1** → **2** → **3**.

NOTE: Make sure there is no gap between the left rear splash guard and the vehicle body. If there is a gap, loosen the self-tapping screw, hold the splash guard against the body, and retighten the screw.

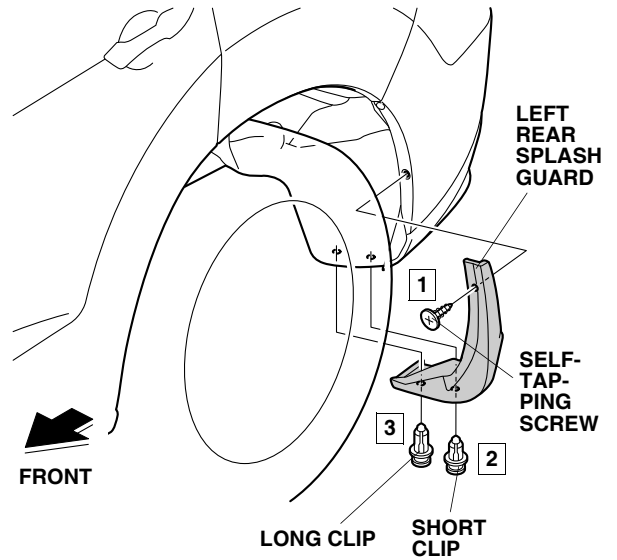

9. Repeat steps 6 through 8 to install the right rear splash guard.