



INSTALLATION INSTRUCTIONS

Accessory

SURFBOARD ATTACHMENT
P/N 08L05-TA1-200

Application

2010 RDX

Publications No.

BII 42039

Issue Date

JULY 2009

Put this information in the glove box with the vehicle owner's manual.

PARTS LIST

4 Bases

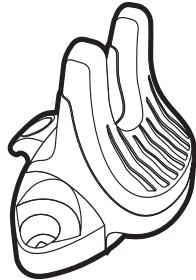

8 Knobs



8 Bolts



2 Attachment straps

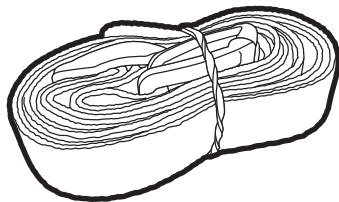

4 Metal brackets

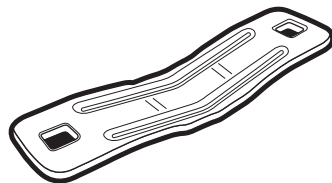

INSTALLATION

NOTE: Be careful not to damage the body paint finish.

1. Loosely install one bolt and knob as shown.

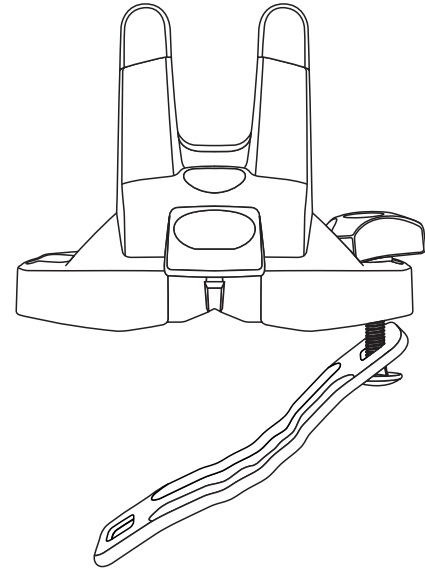

2. Position the base on the crossbar. Loosely install one bolt and knob as shown.

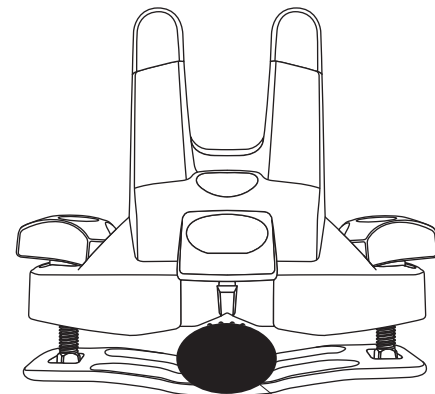

3. Repeat steps 1 and 2 for the three remaining bases.

- Center the surfboard upside down on the roof of the vehicle with the tail toward the front of the vehicle.

NOTE: When mounting two boards, place the second board on top of the first.

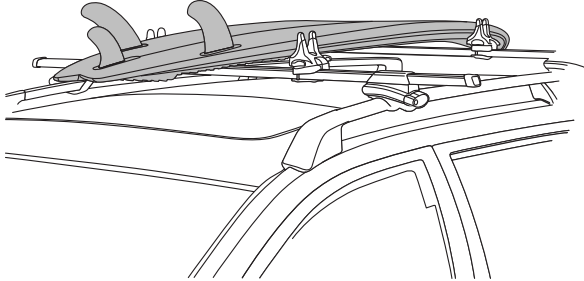

- Adjust the position of the bases so that the bottom of the surfboard rests on the rubber part of the bases. Tighten all knobs firmly and evenly.

NOTE: The crossbars must be at least 24 in. (610 mm) apart for safe use.

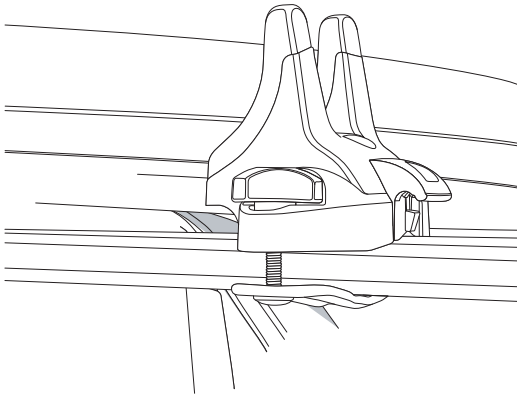

- Slide the buckle on the attachment strap into the clip on the base.

NOTE: For proper alignment, the buckle must be fully inserted into the clip as shown.

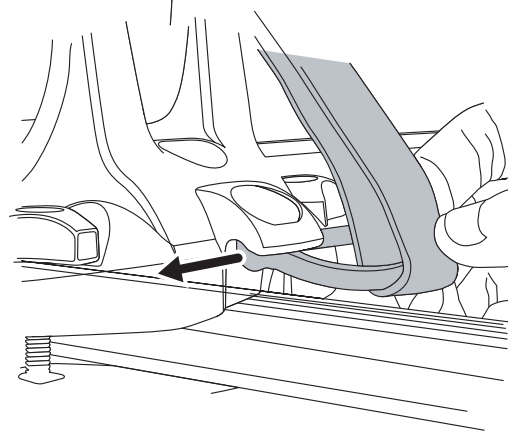

- Rotate the buckle up to lock it into the base. Repeat this step for the remaining bases.

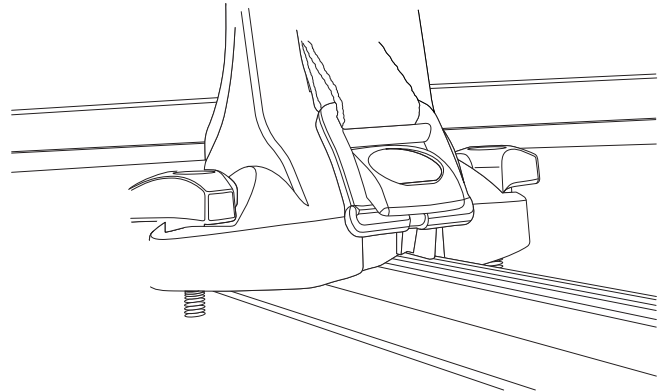

8. Pull the end of the attachment straps to secure the surfboard to the carrier. Make certain all mounting hardware is secure, then tighten as necessary.

NOTE: Be careful not to overtighten the attachment straps as you could damage the surfboard.

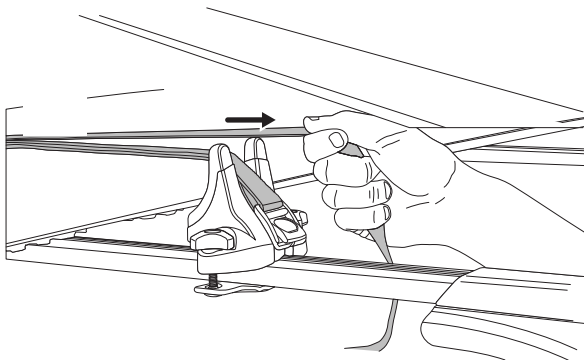

Surfboard Removal

1. Open the latches to loosen the attachment straps.

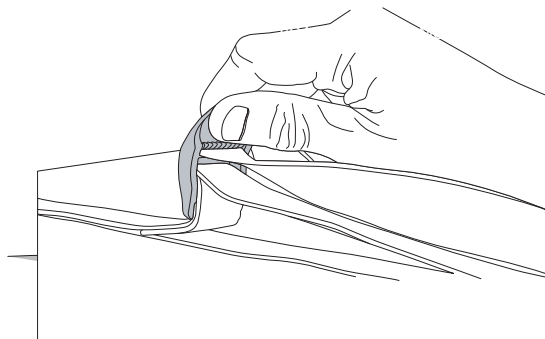

2. Rotate the buckles down to unlock the attachment straps, and slide the buckles out of the bases.

