



# INSTALLATION INSTRUCTIONS

Accessory

**SURFBOARD ATTACHMENT**  
P/N 08L05-TA1-200

Application

**2010 MDX**

Publications No.

**BII 42103**

Issue Date

**NOV 2009**

**Put this information in the glove box with the vehicle owner's manual.**

## PARTS LIST

4 Bases

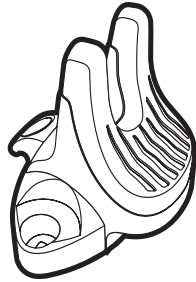

8 Knobs



8 Bolts



2 Attachment straps

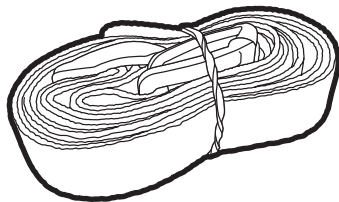

4 Metal brackets

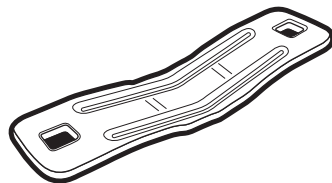

## INSTALLATION

### NOTE:

- The surfboard attachment is designed to be used exclusively with an Acura roof rack, which is sold separate. If the vehicle is not equipped with a roof rack, install a roof rack before installing the surfboard attachment.
  - Be careful not to damage the body paint finish.
1. Loosely attach a bolt and knob to a base and metal bracket, as shown.

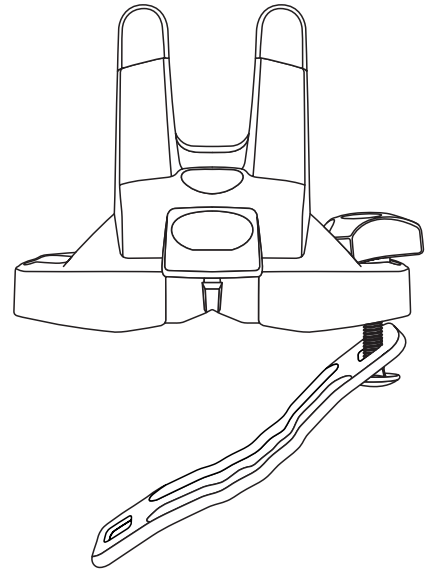

2. Position the base on one crossbar on the roof rack. Loosely install another bolt and knob as shown.

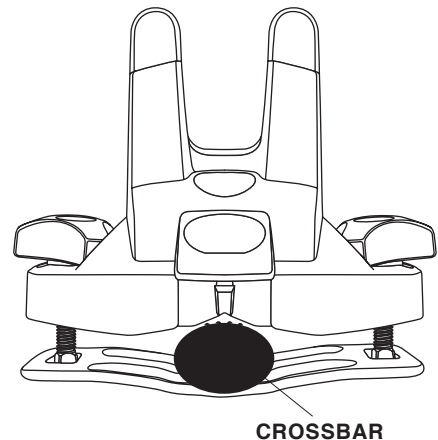

3. Repeat steps 1 and 2 for the three remaining bases, attaching the last two bases to the other crossbar.
4. Center the surfboard upside down on the roof rack with the tail toward the front of the vehicle.

**NOTE:** When mounting two boards, place the second board on top of the first.

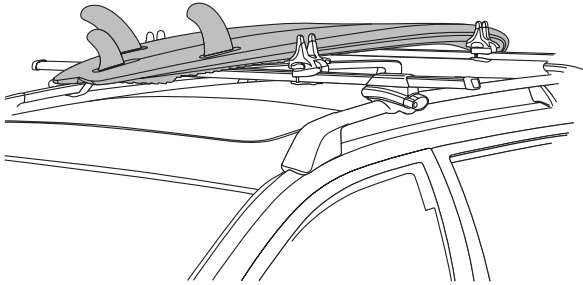

5. Adjust the position of the bases so that the bottom of the surfboard rests on the rubber part of the bases. Tighten all knobs firmly and evenly.

**NOTE:** The roof rack crossbars must be at least 24 in. (610 mm) apart for safe use.

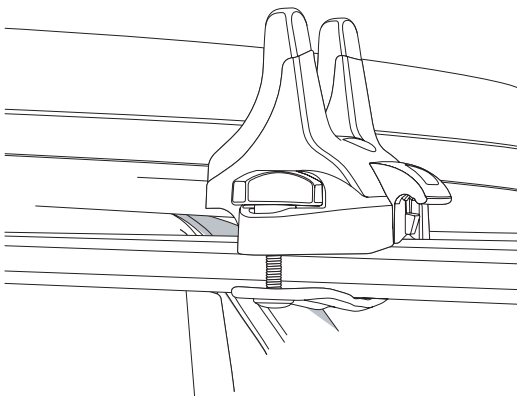

6. Slide the latch on one attachment strap into the clip on the base.

**NOTE:** For proper alignment, the latch must be fully inserted into the clip as shown.

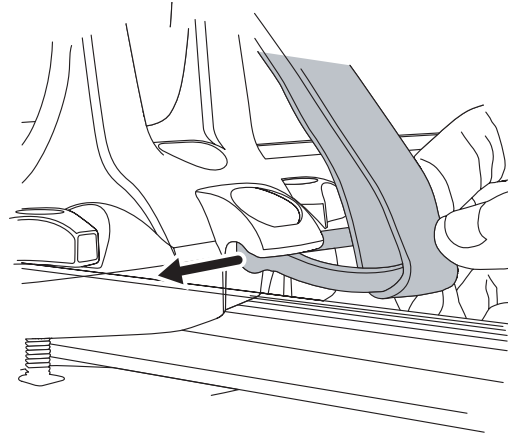

7. Rotate the latch up to lock it into the base. Repeat this step at the other base on the crossbar.

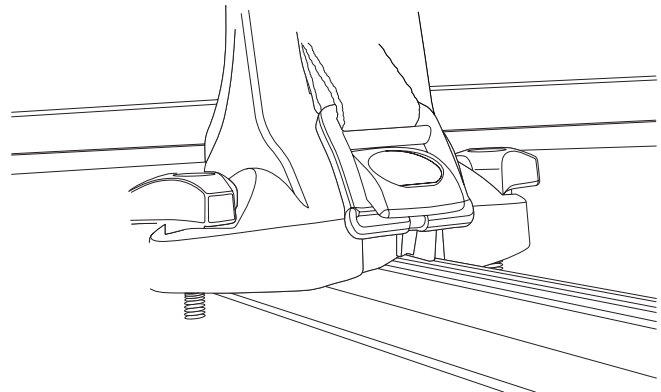

8. Repeat steps 6 and 7 to secure the other attachment strap to the other crossbar.

9. Pull the end of the attachment straps to secure the surfboard to the carrier. Make certain all mounting hardware is secure, then tighten as necessary.

**NOTE:** Be careful not to overtighten the attachment straps as you could damage the surfboard.

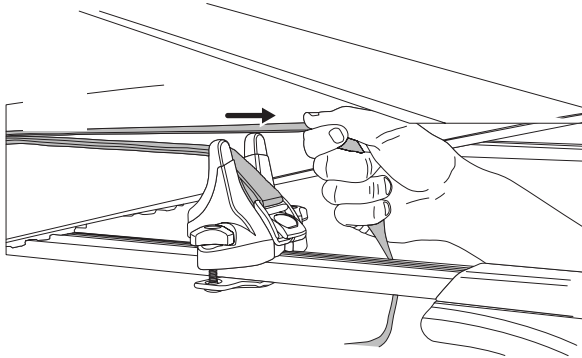

## Surfboard Removal

1. Open the buckles to loosen the attachment straps.

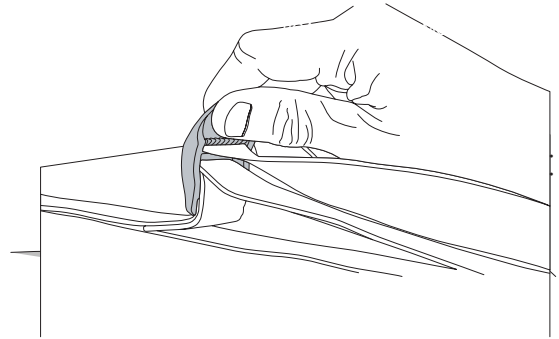

2. Rotate the latches down to unlock the attachment straps and slide the latches out of the bases.

