



ACURA INSTALLATION INSTRUCTIONS

Accessory	Application	Publications No.
SPLASH GUARDS	2008 RDX	BII 37445
		Issue Date
		JUL 2007

PARTS LIST

Right front splash guard

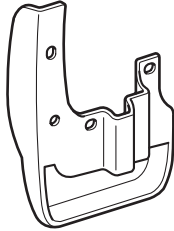

Left front splash guard

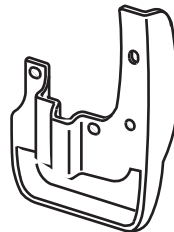

Right rear splash guard

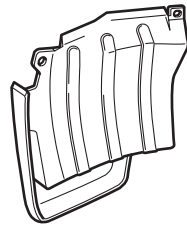

Left rear splash guard

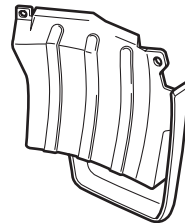

2 Washer screws, 5 x 30 mm



2 Clips



TOOL AND SUPPLIES REQUIRED

Stubby Phillips screwdriver

Clip remover

INSTALLATION

NOTE:

- These instructions show the left splash guard being installed. The same procedure applies to installing the right splash guard.
- Make sure the area to be covered is clean, and waxed.

Installing the Front Splash Guards

1. Turn the steering wheel all the way counterclockwise.
2. Remove and retain the four self-tapping screws that fasten the left front inner fender to the fender and fenderwell.

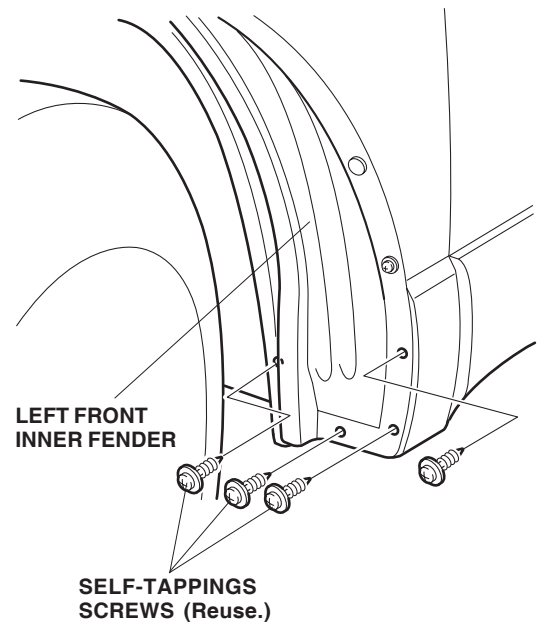

- Position the left front splash guard on the left front inner fender, and install the four self-tapping screws you removed. Tighten the four self-tapping screws in the order shown.

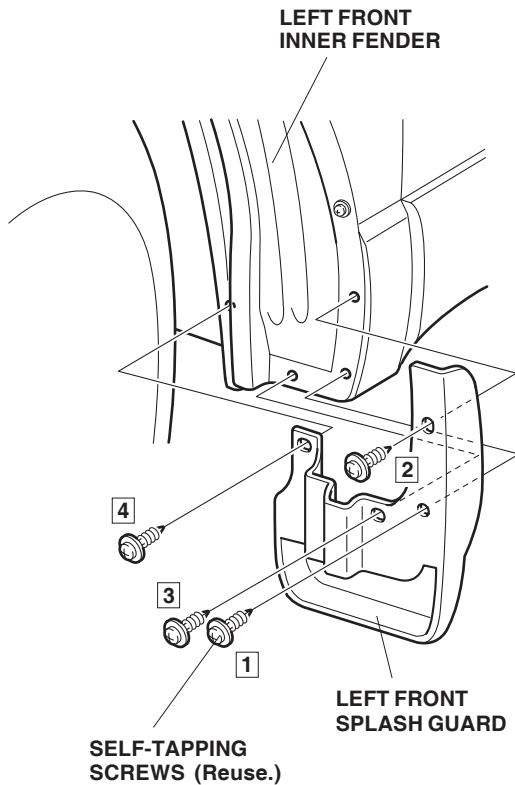

- Turn the steering wheel all the way clockwise, and repeat steps 2 and 3 to install the right front splash guard.

Installing the Rear Splash Guards

- Remove the two self-tapping screws and one clip from the left rear inner fender.

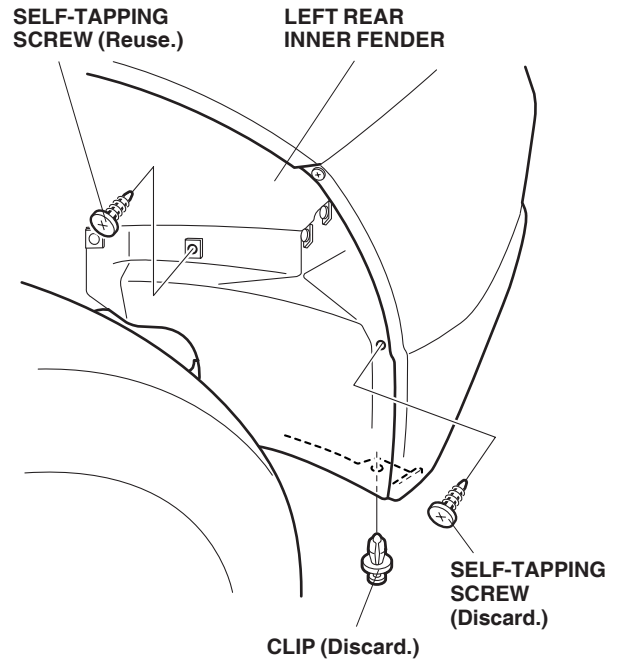

- Position the left rear splash guard on the rear bumper and inner fender, and install the one clip and one washer screw provided, and the one self-tapping screw removed in step 5.

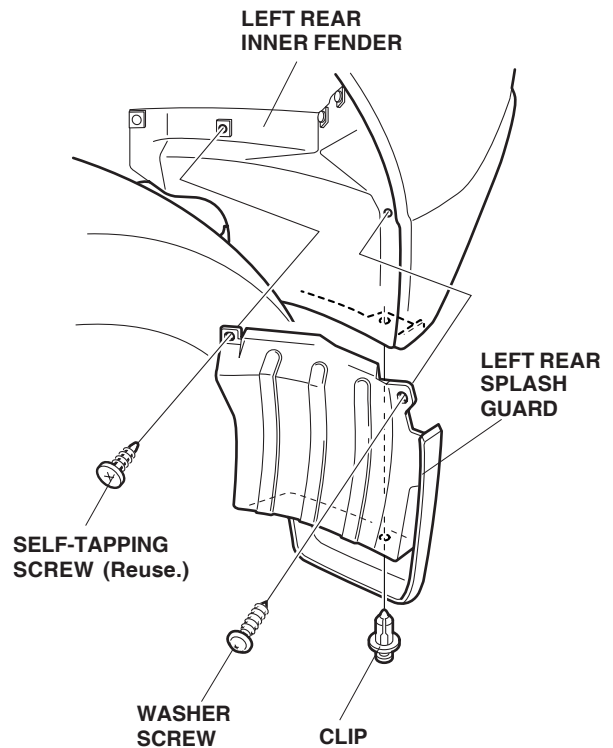

- Repeat steps 5 and 6 to install the right rear splash guard.