



# ACURA

## INSTALLATION INSTRUCTIONS

Accessory	Application	Publications No.
18" ALUMINUM WHEEL	2007 TL	<b>BII 33639</b>
		Issue Date
		<b>SEP 2006</b>

### PARTS LIST

Aluminum wheel  
(The illustration may differ from the actual wheel.)

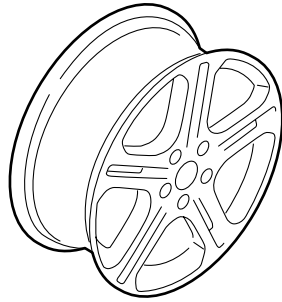

Wheel center cap  
(The illustration may differ from the actual center cap.)

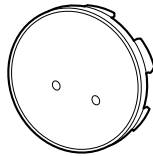

Center cap emblem

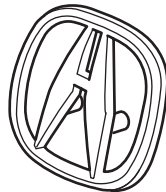

2 Push nuts

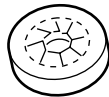

Tire pressure information label A



Tire pressure information label B



Important Information

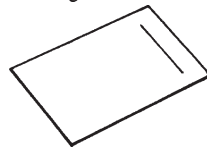

Wheel cleaning information  
(Contained in the kit of 08W18-SEP-202F only. Give this information to your customer.)

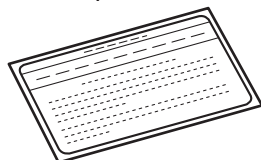

TPMS Information  
(Give this information to your customer.)



### Parts for TPMS sensor assembly

Tire pressure sensor

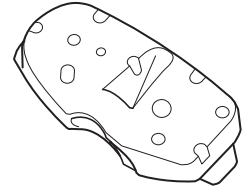

Valve stem

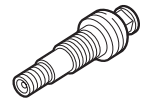

Valve cap



Valve nut

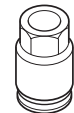

### SUPPLIES REQUIRED

- Ratchet wrench
- 11 mm Socket
- Torque wrench
- Isopropyl alcohol
- Shop towel
- HDS (Honda Diagnostic System)

### SPECIFICATIONS

Rim size	18 x 8 JJ (offset 45)	
Tire size	235/40R18 95W	
Bolt hole PCD	114.3 (5 holes)	
Tire pressure	Front	38 psi (260 kPa, 2.6 kgf/cm <sup>2</sup> )
	Rear	35 psi (240 kPa, 2.4 kgf/cm <sup>2</sup> )

## INSTALLATION

**Customer Information:** The information in this installation instruction is intended for use only by skilled technicians who have the proper tools, equipment, and training to correctly and safely add equipment to your vehicle. These procedures should not be attempted by “do-it-yourselfers.”

### NOTE:

- This aluminum wheel is designed for use on TPMS (Tire Pressure Monitoring System) vehicle.
  - This aluminum wheel is equipped with the TPMS sensor. See the Service Manual for tire replacement procedure and TPMS sensor installation procedure (paragraph of Tire Pressure Sensor Replacement).
  - The illustration of the aluminum wheels shown are for reference purposes only.
  - Install the correct size tire (235/40R18 95W).
  - Use a tire changer to remove and install the tires. Using a tire lever to remove and install the tires can damage the tire, the wheel, and the TPMS sensor.
  - The wheel nut torque is 108 N·m (80 lb-ft)
  - Be careful not to damage the wheel center cap when installing the emblems.
  - This center cap emblem kit should be installed only if the ambient air temperature is 60°F (15°C) or above.
  - To allow the adhesive to “cure,” do not wash the car for 24 hours.
1. Install the valve stem and the screw to the tire pressure sensor.
  2. Before installing the tire pressure sensor, clean the mating surface and the valve hole of the aluminum wheel.

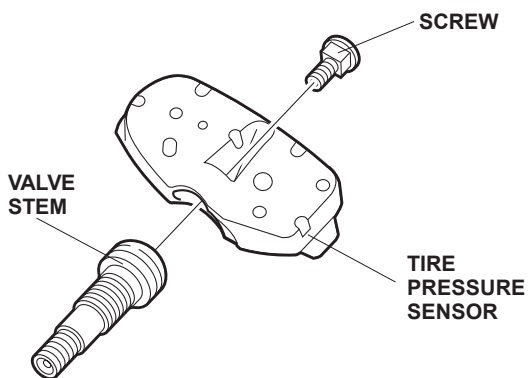

3. Install the tire pressure sensor to the aluminum wheel and loosely install the valve nut. Make sure the pressure sensor is resting on the wheel.

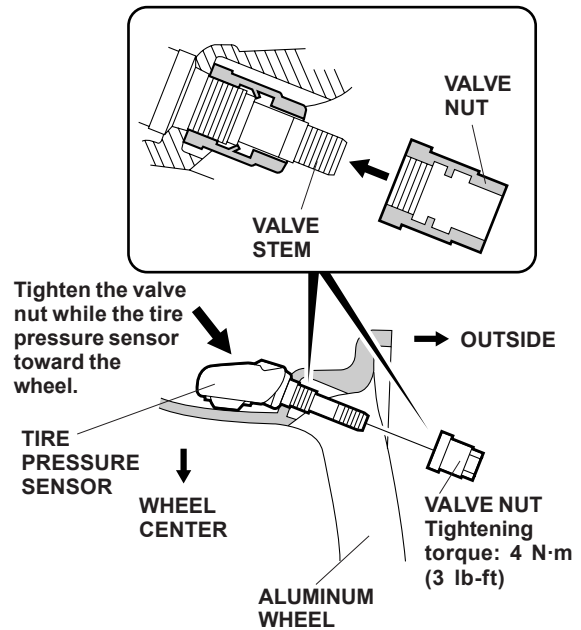

4. Tighten the valve nut to the specified torque while holding the tire pressure sensor toward the wheel. You may hear a snap or pop as you tighten the nut. This is normal.  
Tightening torque: 4 N·m (3 lb-ft)

### NOTE:

- Do not reuse the grommet that had been tightened, even one time, to the specified torque, as they are deformed inside.
  - Do not use air or electric impact tools to tighten a valve stem nut.
  - Tightening the nut beyond the specified torque can damage the nut.
  - Make sure that there is no space between the sensor and the wheel.
5. Install the tires according to the instructions in the Service Manual.
  6. Using isopropyl alcohol on a shop towel, clean the area where the center cap emblem will attach.

- Remove the adhesive backing from the center cap emblem.

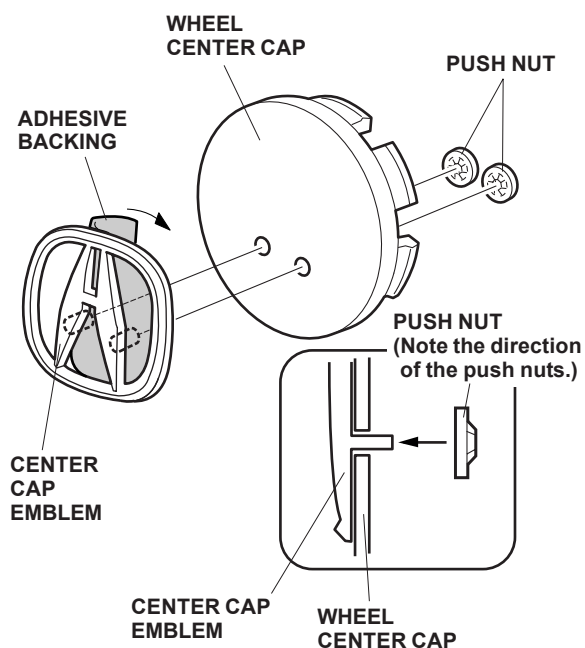

- Attach the center cap emblem to the wheel center cap by aligning its pins with the holes in the wheel center cap. After attaching, hold the emblem firmly against the wheel center cap with the palm of your hand for 30 seconds.
- Slide the push nuts onto the pins. Note the direction of the push nuts.

- Open the driver's side door. Using isopropyl alcohol, clean the area where the accessory tire pressure caution label will attach. Remove the adhesive backing from the label and attach it over the existing tire information label. Attach the tire pressure caution label A or B according to the following information:

**Label A: For BASE Model with a T135/80R16 101M spare tire**

**Label B: For TYPE-S Model with a T145/70R17 106M spare tire**

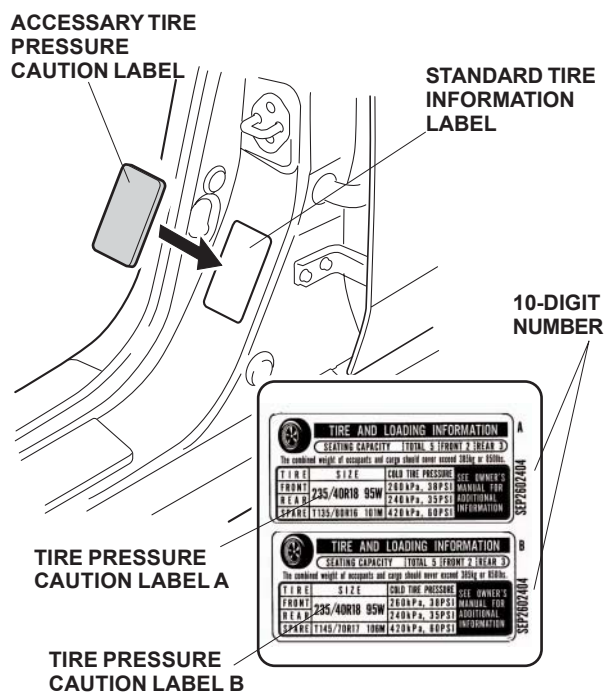

- Memorize the ID tire pressure sensor as described on the next page.

## SENSOR ID LEARNING

NOTE: Before beginning TPMS sensor ID, to ensure the control unit memorizes the correct ID, the vehicle with the new sensor must be at least 3 m (10 ft) from any other TPMS pressure sensor not installed on that vehicle.

12. Connect the HDS to the vehicle, make sure the correct VIN is populated and enter the mileage.
13. At the System Selection Menu, click TPMS
14. At the Mode Menu, click DTC and clear any stored codes.
15. Go back to the Mode Menu, click Sensor ID Learning and follow the screen prompts.

NOTE: If the ID Learning fails, have an assistant drive the vehicle under 10 mph while you start the ID learning process. The TPMS control unit should learn all four sensor IDs. If all four sensors IDs are learned, go to step 17. If one or more of the sensor IDs are not learned, then go to normal troubleshooting in the service manual before continuing.

16. Perform the Inch-up Tire Pressure programming procedure as follows.

## LOW AIR PRESSURE WARNING THRESHOLD REPROGRAMMING

17. After performing the sensor ID learning using the HDS, back up to the TPMS Mode Menu, and click on Threshold Rewriting.
18. Select "Reprogramming for accessory tires".
19. Do you want to rewrite the threshold data? Click "YES".
20. Check "Please enter the tire information code of new tires" is shown, and click "Key board" icon.
21. Enter the 10-digit tire information code printed on the new tire pressure information label, then click the check icon.
22. Check that the tire pressure shown on HDS, and the new tire pressure on the tire information label are the same, click "YES" button for programming.
23. Check that current air pressure setting shown on HDS is correct and "Reprogramming the threshold data for non-standard tires has completed successfully" is shown.
24. After programming, write the tire pressure indicated on the HDS in the service history page for Acura Accessory Wheels, then click the check icon.
25. After programming, sign on the service history page for the Acura Accessory wheels, according to the procedure on page 5.

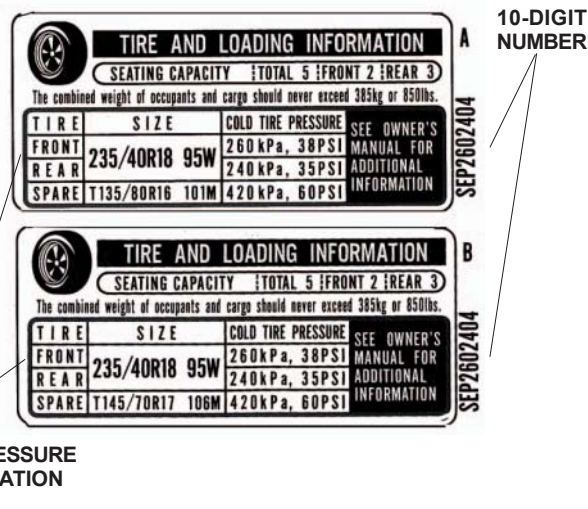
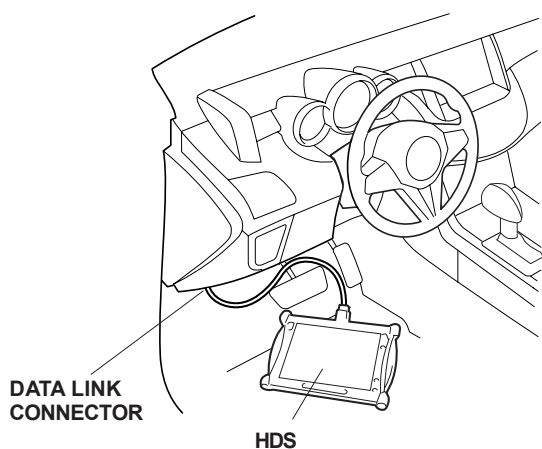

26. After finishing the work, write tire size, tire pressure, HDS version, dealer name, technician's signature and date in service history page for Acura Accessory Alloy wheels page included in this kit to the vehicle's Owner's Manual.
27. Attach the "Supplemental information for using 18" Acura Accessory Alloy wheels page included in this kit to the vehicle's Owner's Manual. To install this page to the Owner's Manual, refer to the "To Dealer" label attached to the "Supplemental information for using 18" Acura Accessory Alloy Wheels" page.

Be sure to explain the contents of the  
"Important Information" to your customer before  
delivering the vehicle.

28. Be sure to give the wheel cleaning information and TPMS information to your customer.

## **STANDARD TIRE PRESSURE PROGRAMMING**

If the original equipment (standard) tire are to be installed back on the vehicle, the low pressure warning threshold must be changed back, follow the procedure on page 7.

## **THRESHOLD DATA CHECK**

If for some reason you are unsure of where the low pressure warning threshold is set, it can be checked by using Threshold Data Check, follow the procedure on page 8.

## **TPMS Unit Replacement**

If the TPMS control is ever replaced and the vehicle has inch up wheels, the low pressure sensor threshold must be changed, once the TPMS control is installed follow steps 13 to 29 (which includes ID learn and programming for accessory tires).

## STANDARD TIRE PRESSURE PROGRAMMING

To return the TPMS programming from the inch-up tire to the standard tire, change the programming in the following procedure.

- 1). Connect the HDS to the vehicle make sure the correct VIN is populated and enter the mileage.
- 2). At the System Selection Menu, click TPMS.
- 3). At the Mode Menu, Click the DTC and clear any stored codes.
- 4). Go back to the Mode Menu, click on Threshold Rewriting.
- 5). Click on Reprogramming for standard tires and follow the screen prompts.
- 6). After programming, write the measured tire pressure in the important information, then click the check button.
- 7). Attach the tire pressure information label for standard tire at the prescribed location.
- 8). After programming, sign on the service history page for Acura Accessory wheels, according to the procedure shown on page 5.

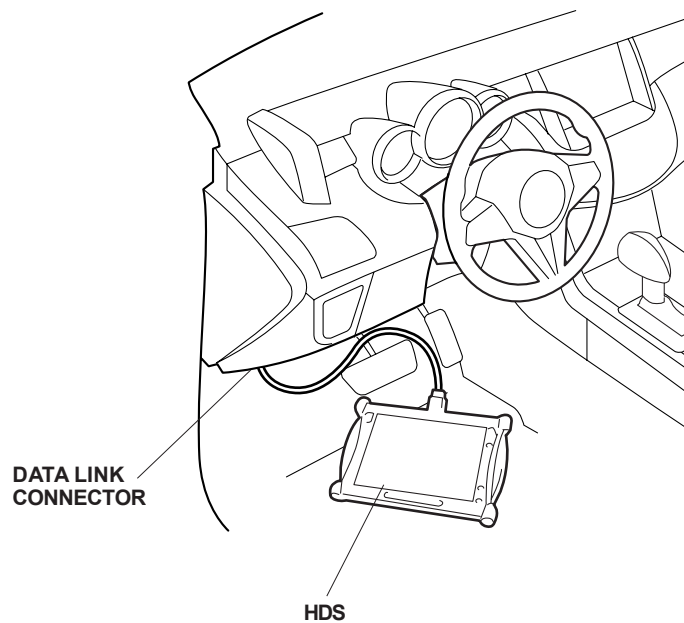

## THRESHOLD DATA CHECK

Check the TPMS programming of the pressure on the car as following procedure.

- 1). Connect the HDS to the vehicle and make sure the correct VIN is populated and enter the mileage.
- 2). At the System Selection Menu, click TPMS.
- 3). Click on Threshold Rewriting.
- 4). Click on Threshold Data Check.

