



**ACURA**

**INSTALLATION  
INSTRUCTIONS**

Accessory

**FENDER FLARES  
P/N 08P21-STX-200**

Application

**2007 MDX**

Publications No.

**BII 32743**

Issue Date

**OCT 2006**

**PARTS LIST**

Left front fender flare



Left front bumper flare

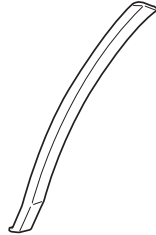

Left rear fender flare

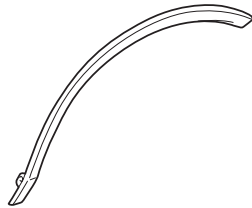

Left rear bumper flare



Right front fender flare



Right front bumper flare

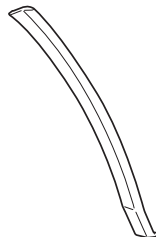

Right rear fender flare

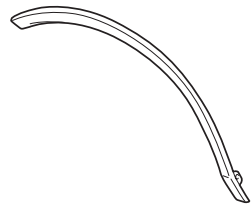

Right rear bumper flare



Left bracket A



Left bracket B

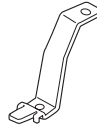

Right bracket A

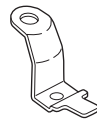

Right bracket B

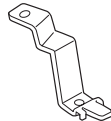

4 Self-tapping screws, 5 x 20 mm



4 Spring nuts



6 Expansion clips



2 Self-tapping screws, 5 x 12 mm



4 Black films

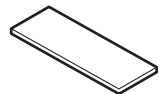

10 Alcohol pads

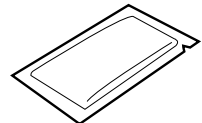

## TOOLS AND SUPPLIES REQUIRED

Stubby Phillips screwdriver  
Phillips screwdriver  
Flat-tip screwdriver  
Ratchet  
10 mm Combination wrench  
Isopropyl alcohol  
Shop towel  
Masking tape

## INSTALLATION

**Customer Information:** The information in this installation instruction is intended for use only by skilled technicians who have the proper tools, equipment, and training to correctly and safely add equipment to your vehicle. These procedures should not be attempted by "do-it-yourselfers."

### NOTE:

- Be careful not to damage the finished surfaces of the body when installing the fender flares.
- This fender flare kit should be installed only when the ambient air temperature is 60°F (15°C) or above.
- To allow the adhesive to cure, do not wash the vehicle for 24 hours.
- These instructions show the left fender flares being installed; the same procedure applies to installing the right fender flares.
- This fender flare kit cannot be installed on a vehicle equipped with a full nose mask.

## Installing the Front Bumper Flare

1. Locate the two dimple marks on the front bumper. Slide a spring nut over each of the two marks.

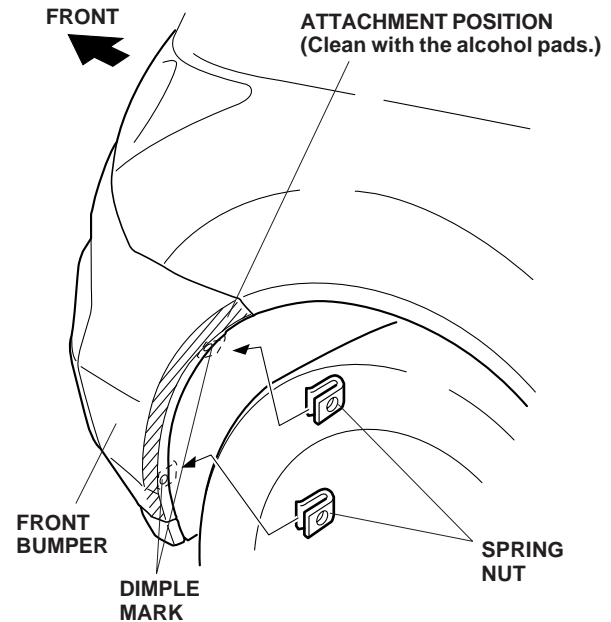

2. Using one alcohol pad provided, thoroughly clean the area where the front bumper flare will attach.
3. Peel back one inch of the adhesive backing, and attach it to the front of the front bumper flare with masking tape. Remove the small piece of adhesive backing from the top of the front bumper flare.

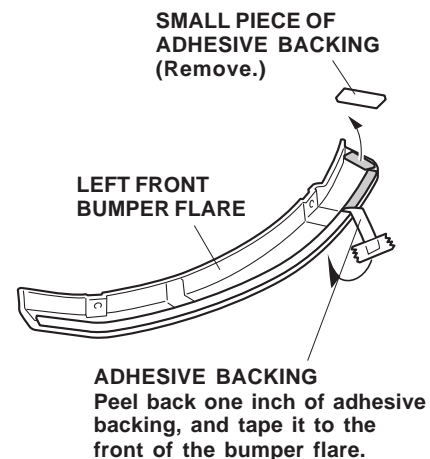

- Position the front bumper flare on the front bumper, and align it with the bottom edge of the front bumper. Install two self-tapping screws (5 x 20 mm) through the bumper, but do not tighten them yet.

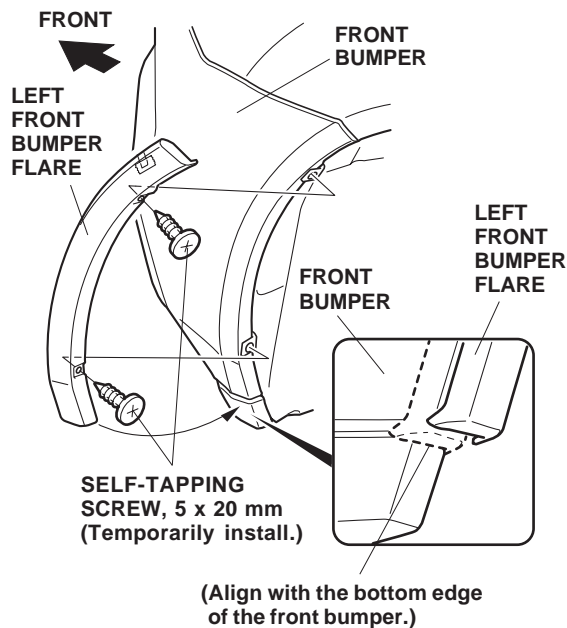

- Remove the adhesive backing from the front bumper flare. Slowly and carefully peel the adhesive backing from the front bumper flare.
  - After removing the adhesive backing, press the front bumper flare firmly against the front bumper with the palm of your hand, particularly at the edges.
  - Tighten the two self-tapping screws.

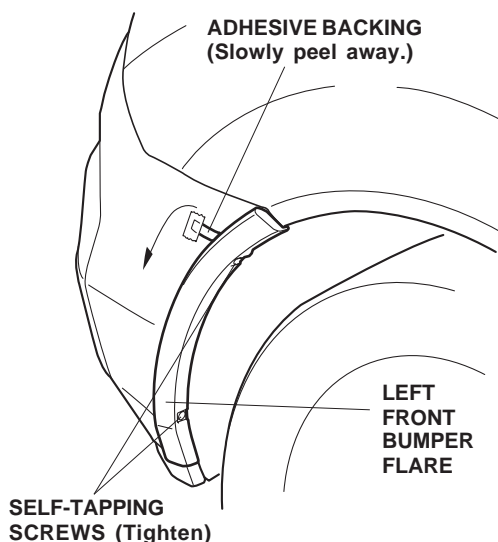

## Installing the Front Fender Flare

- Remove the two expansion clips fastening the left front inner fender, and loosen the three self-tapping screws fastening the splash guard.

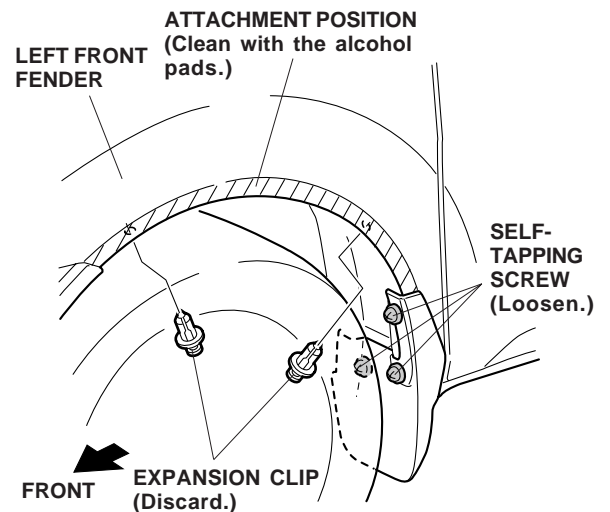

- Using one alcohol pad provided, thoroughly clean the front fender where the fender flare will attach.
- Pull the top of the left front splash guard toward you, and attach the black film from the left fender to the left inner fender as shown.

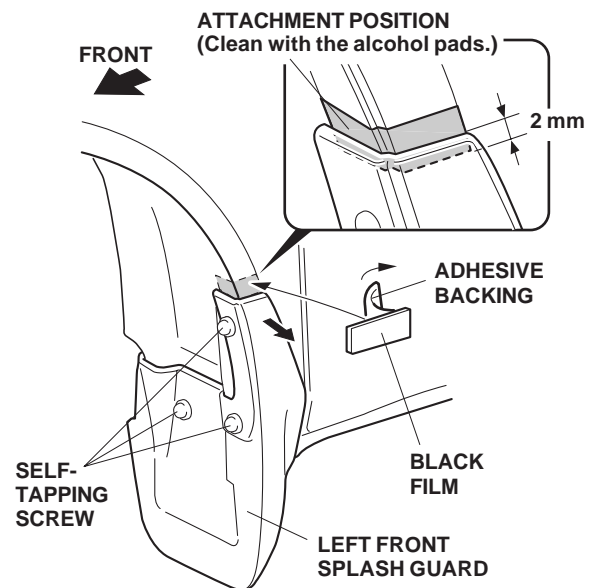

- Place the left front splash guard in its original position, and tighten the three self-tapping screws.

10. Peel back one inch of the adhesive backing, and attach it to the front fender flare with masking tape. Remove the small piece of adhesive backing from the front fender flare.

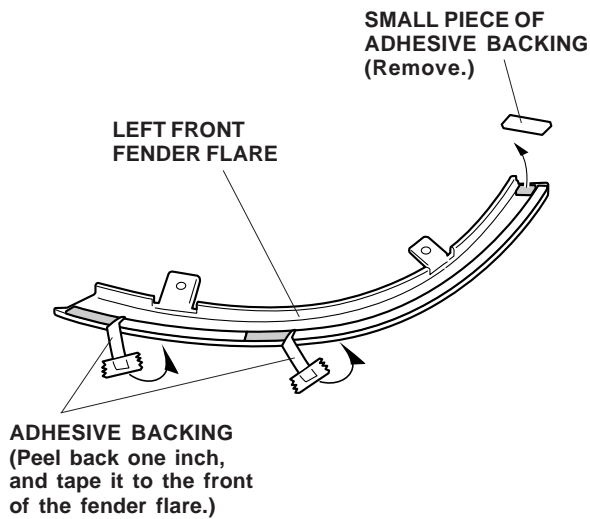

11. Align the front edge of the front fender flare with the front fender flange, and install the two new expansion clips through the holes in the fender flare and fender flange.

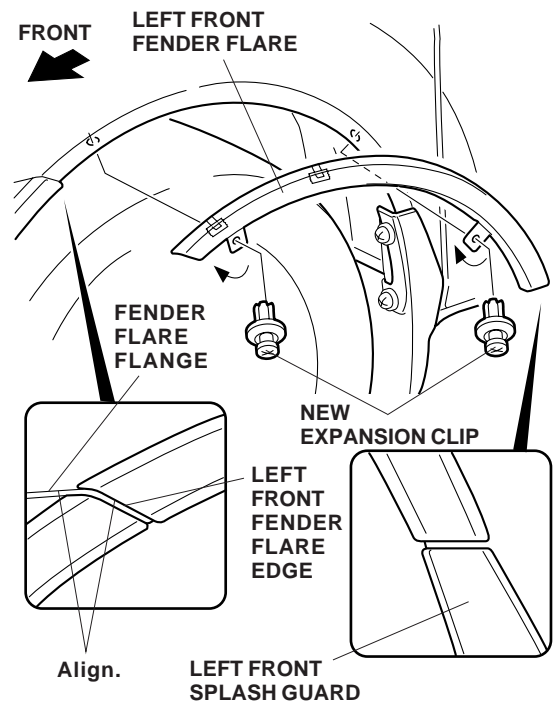

12. Starting at the front edge, remove the adhesive backings from the fender flare:

- Slowly and carefully peel the adhesive backings from the fender flare.
- After removing all of the adhesive backings, press the fender flare firmly against the fender with the palm of your hand for 30 seconds particularly at the edges.

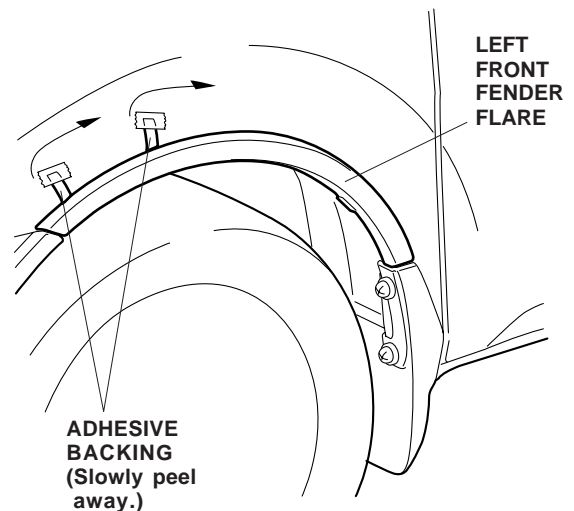

## Installing the Rear Bumper Flare

- Remove the self-tapping screw that fastens the left side of rear bumper to the fenderwell.

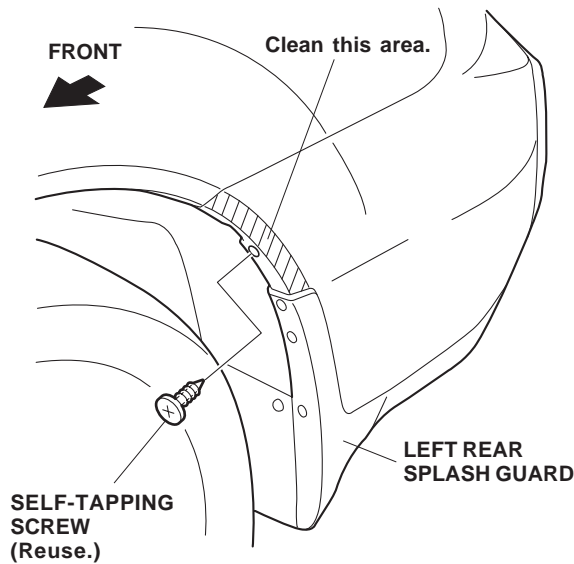

- Using one alcohol pad provided, thoroughly clean the area where the rear bumper flare will attach.

- Remove the four self-tapping screws and one expansion clip that fastens the left rear splash guard.

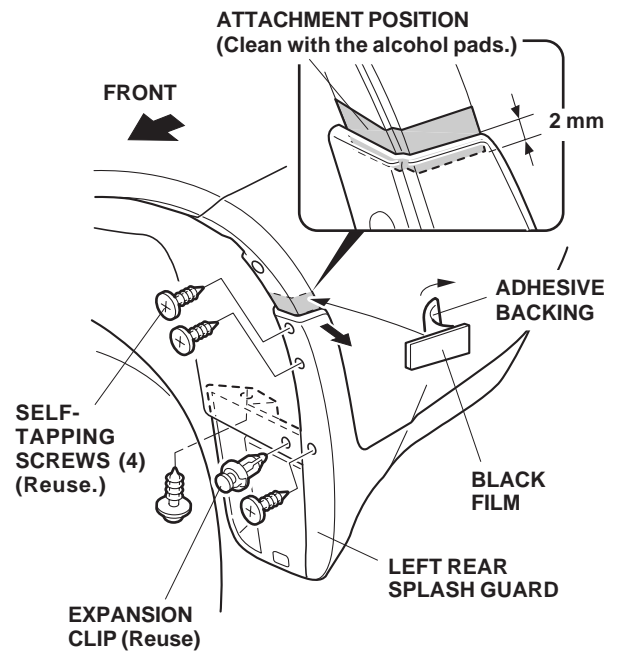

- Pull the top of the left rear splash guard toward you, and attach one black film to the left inner fender as shown.
- Place the left rear splash guard in its original position, and reinstall the four self-tapping screws and one expansion clip.
- Peel back one inch of adhesive backing, and attach it to the front of the rear bumper flare. Remove the two small pieces of adhesive backing from the rear bumper flare.

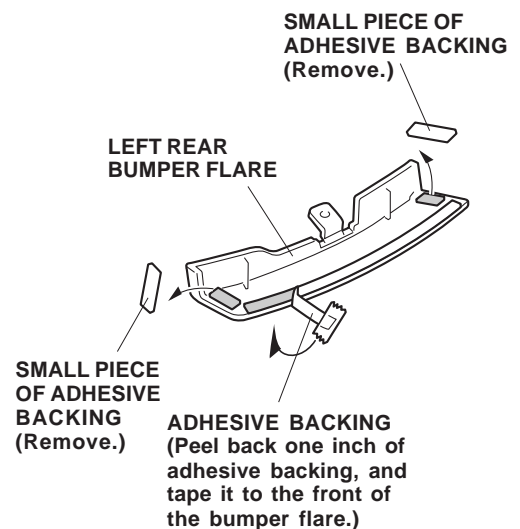

- Position the rear bumper flare on the rear bumper, and align it with the top edge of the rear bumper. Install the self-tapping screw through the rear bumper flare, but do not tighten it yet.

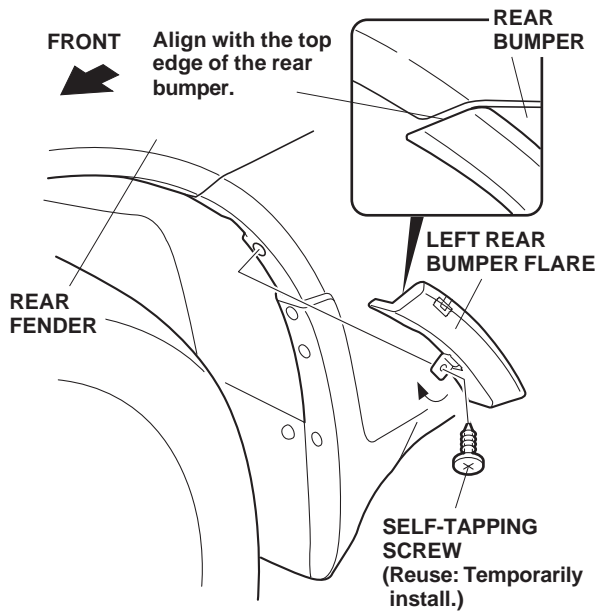

- Remove the adhesive backing from the rear bumper flare. Slowly and carefully peel the adhesive backing from the rear bumper flare.

- After removing the adhesive backing, press the rear bumper flare firmly against the rear bumper with the palm of your hand for 30 seconds particularly at the edges.
- Tighten the self-tapping screw.

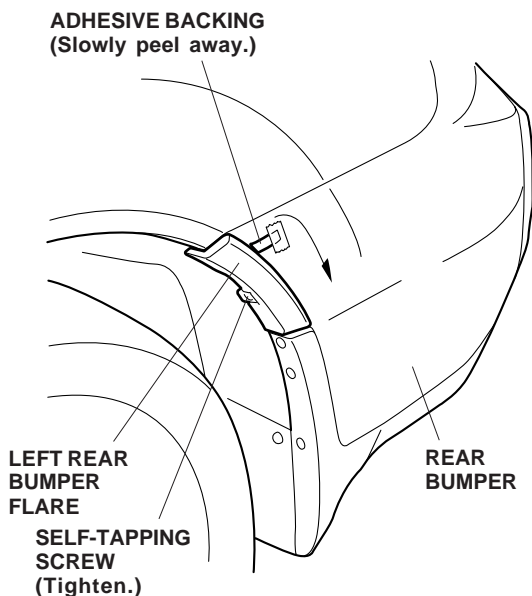

## Installing the Rear Fender Flare

- Remove the expansion clip and bolt from the left rear inner fender flange.

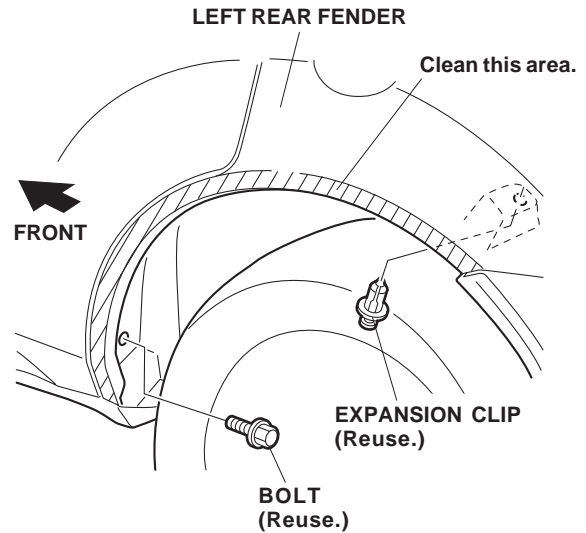

- Using one alcohol pad provided, thoroughly clean the area where the rear fender flare will attach.
- Install the left bracket A with the tab behind the metal flange using the bolt you just removed, but do not tighten it yet.

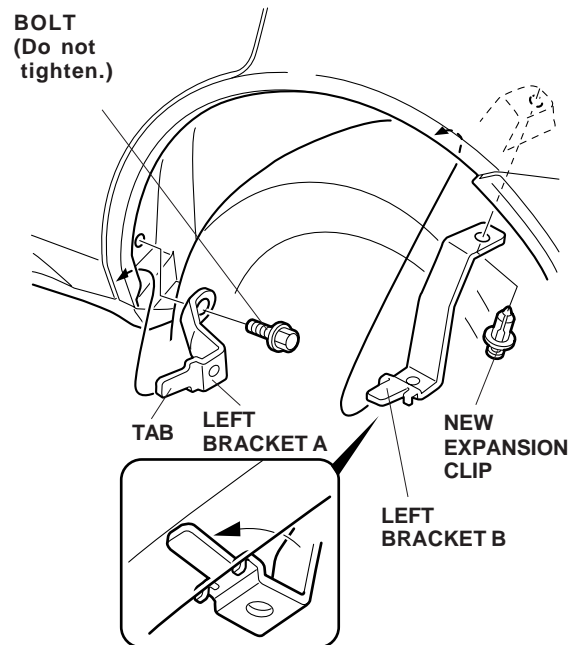

- Install the left bracket B with the new expansion clip.

25. Peel back one inch of the adhesive backings, and attach them to the front of the rear fender flare with masking tape. Remove the two small pieces of adhesive backing from the rear fender flare.

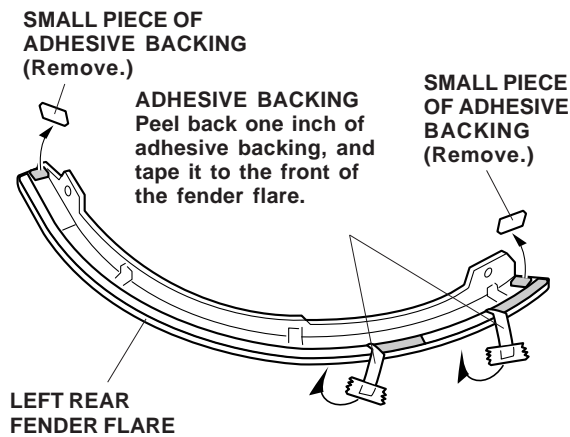

26. Position the rear fender flare on the rear fender as shown.

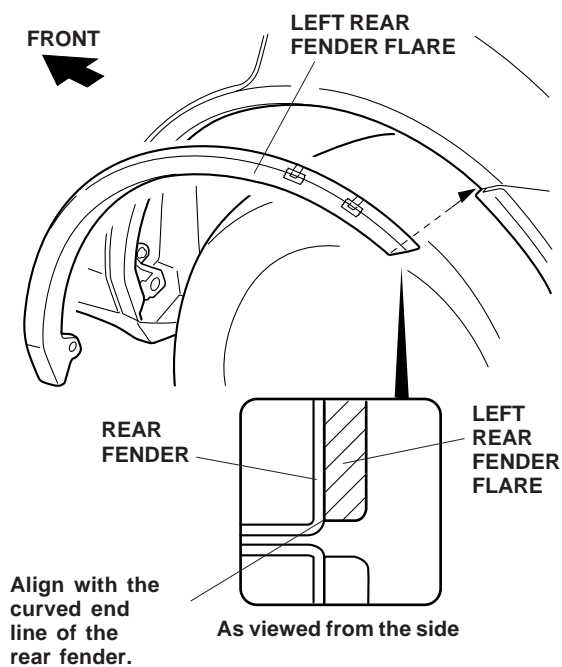

27. Align the hole of left bracket A with the hole of the left rear fender flare and tighten the bolt installed in step 23.

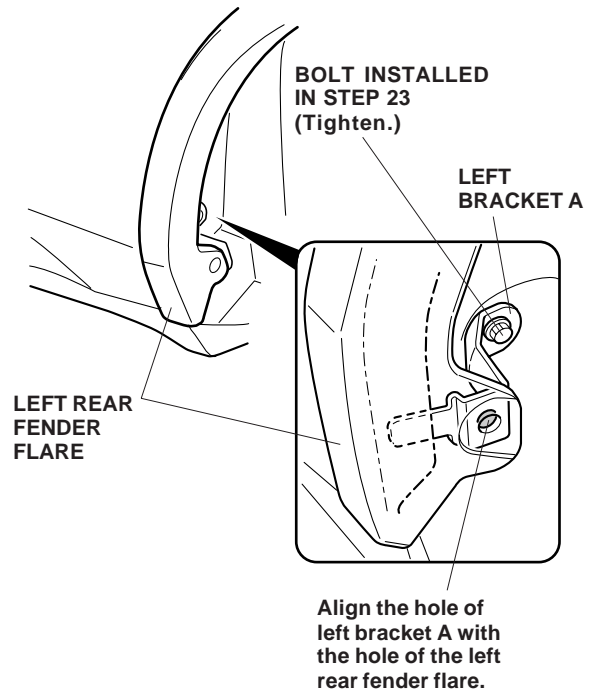

28. Install one 5 x 12 mm self-tapping screw and the expansion clip (removed in step 21) through the holes in the fender flare and the brackets A and B. Do not tighten the screw yet.

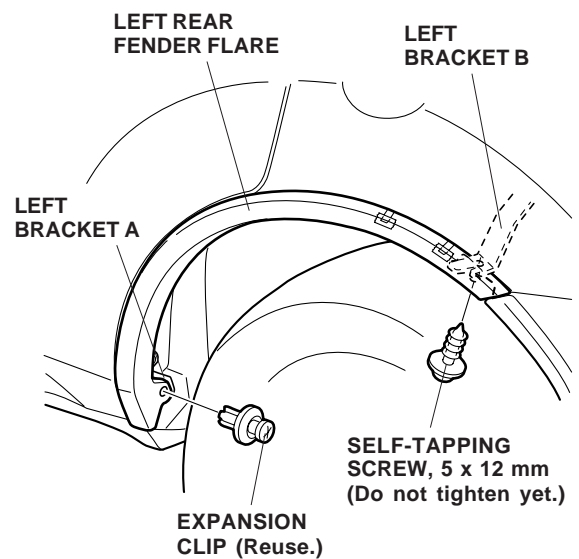

29. While pushing up on the rear fender flare, remove the adhesive backing from the rear fender flare. Slowly and carefully peel the adhesive backing from the rear fender flare.
- After removing all of the adhesive backing, press the rear fender flare firmly against the fender with the palm of your hand for 30 seconds particularly at the edges.
  - Tighten the self-tapping screw you just installed in step 28.

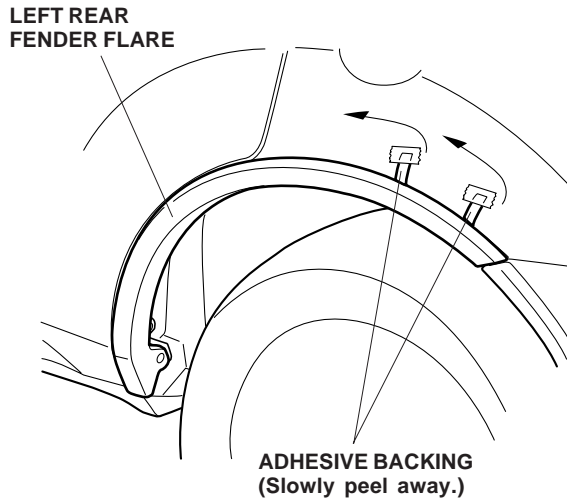

30. Repeat steps 1 through 29 to install the fender flare on the right side of the vehicle.