



INSTALLATION INSTRUCTIONS

Accessory

MOONROOF VISOR
P/N 08R01-SEP-201

Application

2006 TL

Publications No.

BII 30919-34109

Issue Date

NOV 2006

Put this information in the glove box with the vehicle owner's manual.

PARTS LIST

Moonroof visor

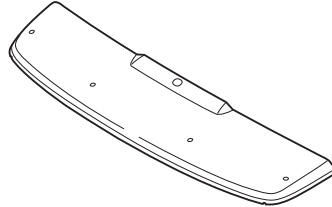

2 Side brackets



2 Front brackets



4 Screws



4 Nuts



4 Protective tapes



TOOLS AND SUPPLIES REQUIRED

Phillips screwdriver

10 mm Combination wrench

Straightedge

Isopropyl alcohol

Shop towel

Masking tape

Felt-tip pen

Torque wrench

INSTALLATION

1. Clean the roof area to be covered, and wax the area with a high-quality paste wax.
2. Open the moonroof.

3. At the right front corner of the moonroof opening, locate the front moonroof guide rail screw. From the guide rail screw, place a straightedge directly outboard from the screw as shown, and mark the edge of the roof with a felt-tip pen.

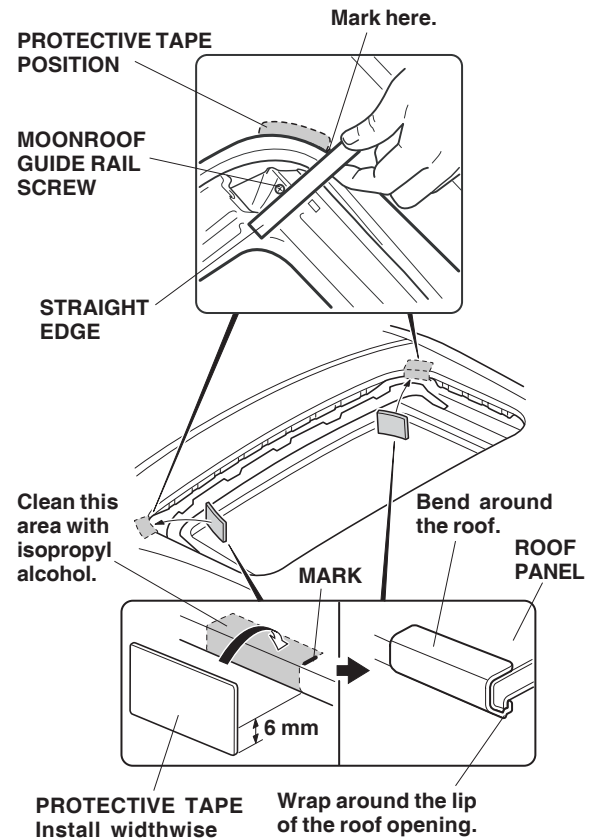

4. Using isopropyl alcohol on a shop towel, clean the roof area and the inside edge of the moonroof opening. Starting at the mark you made, clean about 2 inches toward the front of the opening.
5. Remove the adhesive backing from one protective tape. Align the tape with the mark you made in step 3. Wrap the bottom 6 mm of the tape around the bottom lip of the moonroof opening as shown. Then wrap the tape around to the top of the roof panel.

- Repeat steps 3 thru 5 to install the protective tape on the left side of the moonroof opening. Remove the marks you made using isopropyl alcohol on a shop towel.
- Locate the indentations as shown. Using isopropyl alcohol on a shop towel, clean the roof area where the protective tapes will attach.

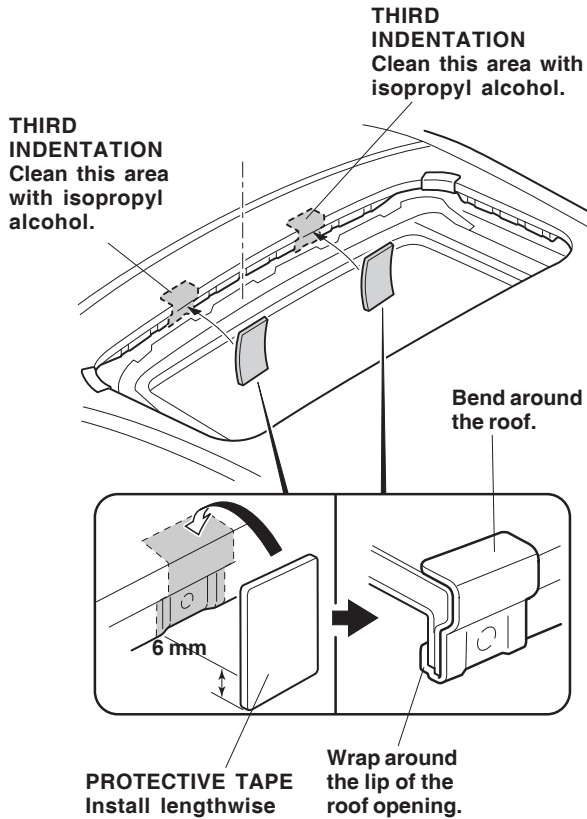

- Install the protective tapes at the third indentations in from each side of the moonroof opening. Remove the adhesive backing from the protective tape and attach one at each position. Wrap 6 mm of protective tape around the lip of the moonroof opening.

- Place the two front brackets and two side brackets into position over the protective tape and around the lip of the roof opening, and tape them into position with a piece of masking tape.

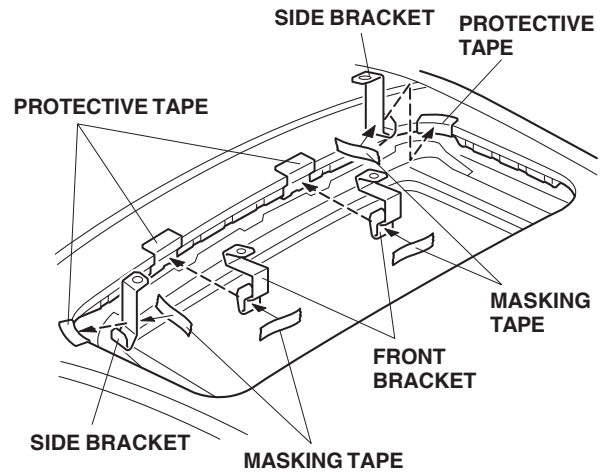

- Set the moonroof visor on the vehicle roof and adjust its position so the holes in the visor are aligned with the side bracket holes. Install two screws and nuts loosely onto the side brackets.

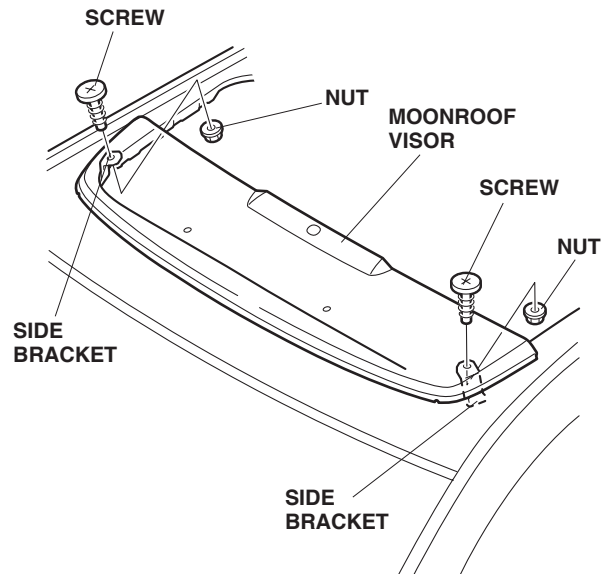

- Align the front bracket holes with the moonroof visor holes. Install the two screws and nuts loosely onto the front brackets.

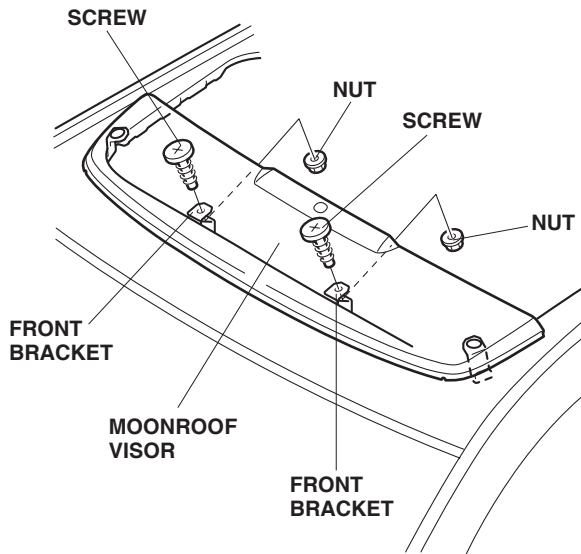

- Position the moonroof visor with equal spacing on all sides. Check that the rubber seal is not twisted or rolled under the visor.

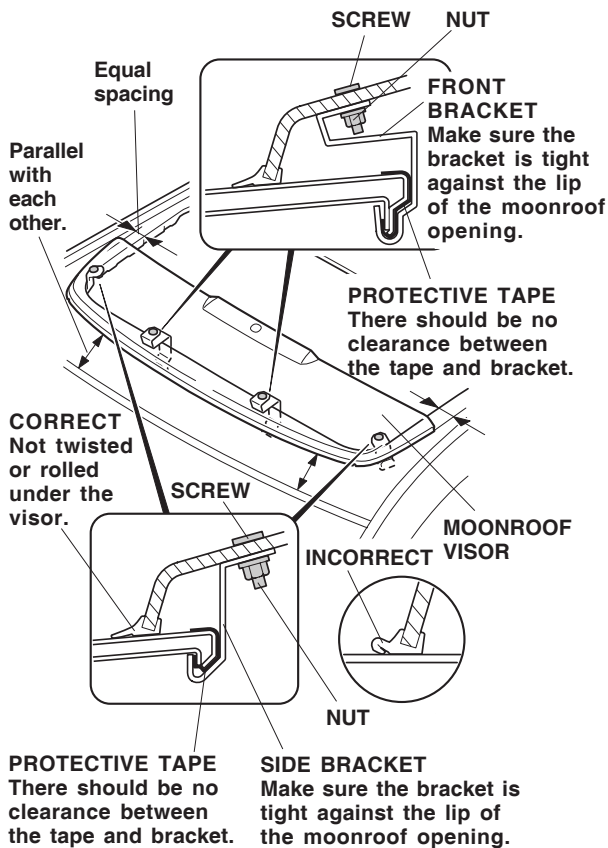

- Torque the screws to 2 N·m (1.5 lb-ft), alternating between sides

CARE OF THE MOONROOF VISOR

- To avoid damaging the surface, never use ammonia-based cleaners or solvents to clean the moonroof visor.
- Clean with a solution of mild dishwashing soap and water using a soft cloth or chamois.
- To remove fine scratches and restore the original luster, use Meguiar's Mirror Glaze plastic cleaner and polish or an equivalent high-quality plastic cleaner.