



INSTALLATION INSTRUCTIONS

Accessory	Application	Publications No.
17" ALUMINUM WHEEL	2006 TL	BII 30990
		Issue Date
		SEP 2005

PARTS LIST

Aluminum wheel
(The illustration may differ from the actual wheel.)

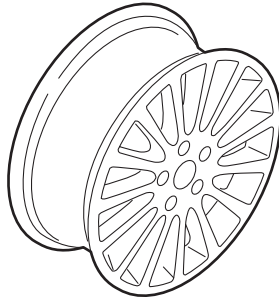

Wheel center cap
(The illustration may differ from the actual center cap.)

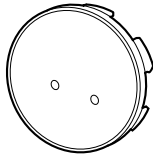

Center cap emblem

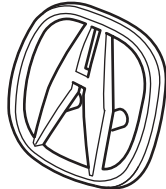

2 Push nuts

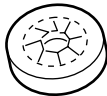

Wheel cleaning information
(Give this information to your client.)

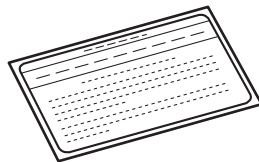

Valve stem

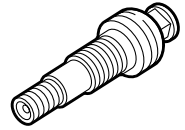

Valve cap



Valve nut

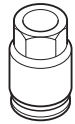

TOOLS AND SUPPLIES REQUIRED

Ratchet wrench

11 mm Socket

Torque wrench

Isopropyl alcohol

Shop towel

INSTALLATION

Customer Information: The information in this installation instruction is intended for use only by skilled technicians who have the proper tools, equipment, and training to correctly and safely add equipment to your vehicle. These procedures should not be attempted by "do-it-yourselfers."

NOTE:

- This aluminum wheel is designed for use on the TPMS cars.
- This aluminum wheel is equipped with the TPMS sensor. See the service manual for tire replacement procedure and TPMS sensor installation procedure.
- The illustration of the aluminum wheels shown are for reference purposes only.
- Install the correct size tire.
- Use a tire changer to remove and install the tires. Using a tire lever to remove and install the tires can damage the tire, the wheel, and the TPMS sensor.
- The wheel nut torque is 108 N·m (11 kgf·m, 80 lb-ft)
- Be careful not to damage the wheel center cap when installing the emblems.
- Install this center cap emblem kit only if the ambient air temperature is 60°F (15°C) or above.
- To allow the adhesive to cure, do not wash the car for 24 hours.

Installing the TPMS Pressure Sensor

1. Remove and discard the valve nut, then remove the tire pressure sensor with valve stem assembly from the wheel.

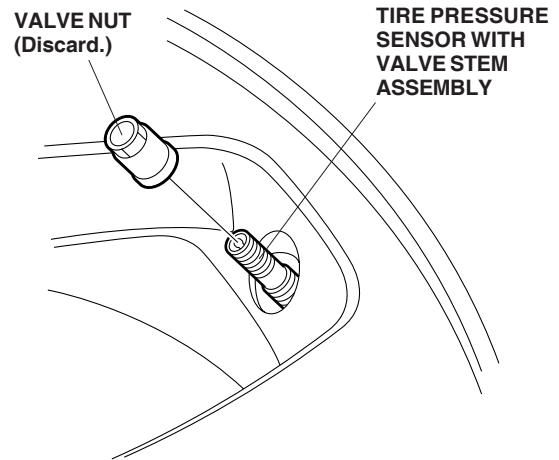

2. Remove and discard the valve stem and the screw from the tire pressure sensor. If the valve stem grommet remained attached to the wheel, remove and discard the grommet before installing the new valve stem.

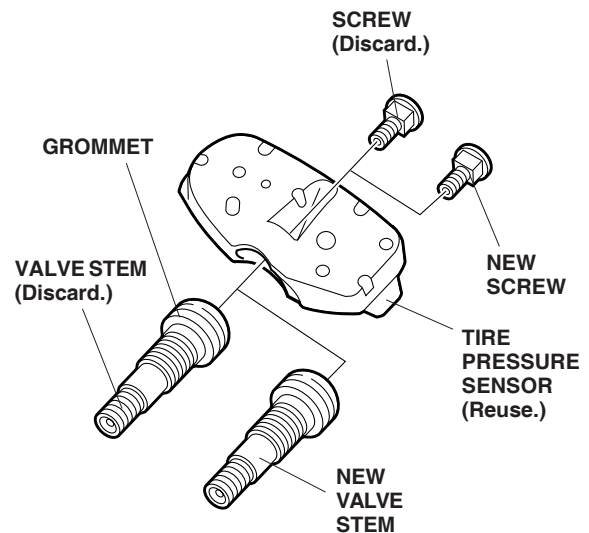

3. Install the new valve stem and screw onto the tire pressure sensor.

- Before installing the tire pressure sensor, clean the wheel mating surface and the valve stem hole of the aluminum wheel.

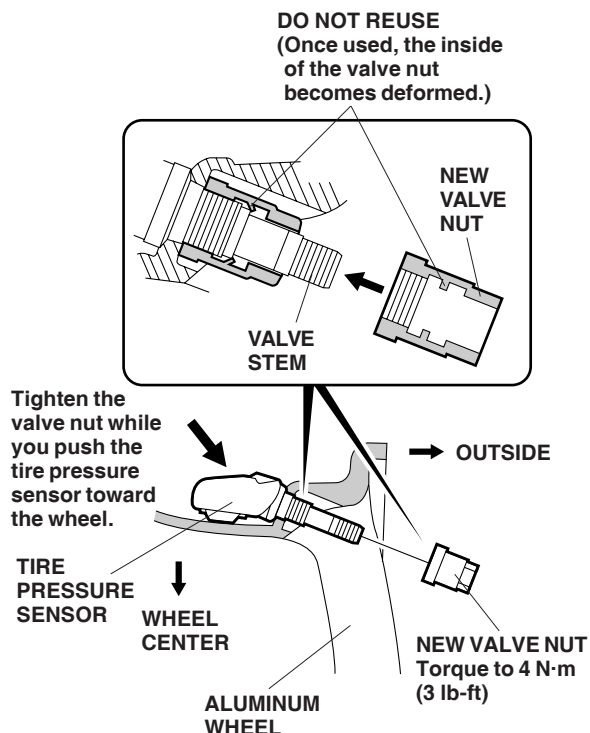

- Install the tire pressure sensor onto the aluminum wheel, and loosely install the valve nut. Make sure the pressure sensor is resting on the wheel.
- While holding the tire pressure sensor toward the wheel, tighten the valve nut. You may hear a snap or pop as you tighten the nut. This is normal. Torque the valve nut to 4 N·m (3 lb-ft.)

NOTE:

- Never reuse any valve nut that had been tightened, even one time. Once used, the inside of the valve nut becomes deformed.
 - Never use pneumatic tools to tighten the valve nut.
 - Tightening the nut above the specified torque will damage the nut.
 - Make sure that there is no space between the sensor and the wheel.
- Reinstall the tires according to the instructions in the service manual.
 - Memorize the tire pressure sensor ID as described in the service manual.

- Using isopropyl alcohol on a shop towel, clean the area where the center cap emblem will attach.

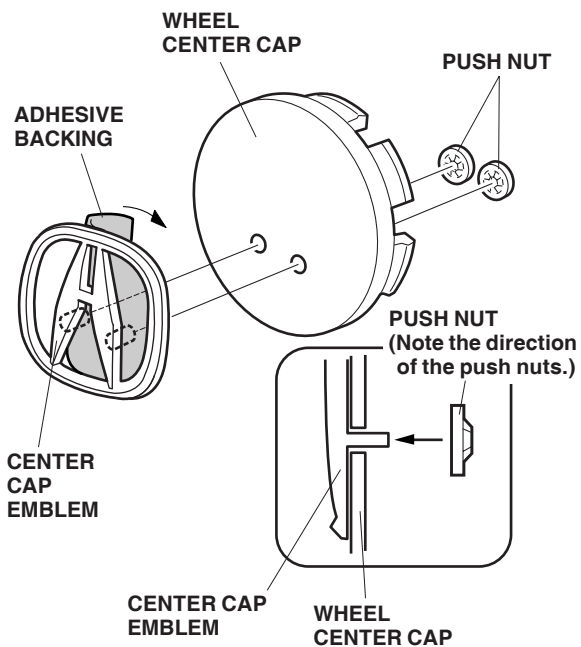

- Remove the adhesive backing from the center cap emblem.
- Attach the center cap emblem to the wheel center cap by aligning its pins with the holes in the wheel center cap. After attaching, hold the emblem firmly against the wheel center cap with the palm of your hand for 30 seconds.
- Slide the push nuts onto the pins. Note the direction of the push nuts.
- Be sure to give the wheel cleaning information to your customer.