



INSTALLATION INSTRUCTIONS

Accessory

ENGINE BLOCK HEATER
P/N 08T44-SJA-200

Application

2005 RL

Publications No.

BII 27030

Issue Date

SEP 2004

NOTE: Installation of the engine block heater requires that the vehicle be raised on a hoist and that the coolant be replaced. This installation should be done only by an authorized dealer.

PARTS LIST

Engine block heater

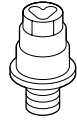

Aluminium washer



Heater harness

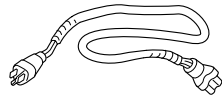

Protective cap

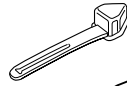

15 Wire ties
(5 Not use)



5 Wire ties with clip
(4 Not use)

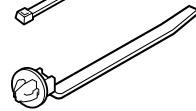

TOOLS AND SUPPLIES REQUIRED

Philips screwdriver

Flat-tip screwdriver

Ratchet

24 mm Socket

Torque wrench

Wrench (1/2 inch)

10 mm Combination wrench

Diagonal cutters

Drain pan

Coolant (Genuine Antifreeze/Coolant only, in a 50/50 mixture with water)

Blanket

Maker

NOTE:

- Always use Genuine Antifreeze/Coolant. Using a non-Honda coolant can result in corrosion, causing the cooling system to malfunction or fail.
- To avoid burning out the element, do not operate the engine block heater before it is installed in the vehicle and before you add coolant.

INSTALLATION

Customer Information: The information in this installation instruction is intended for use only by skilled technicians who have the proper tools, equipment, and training to correctly and safely add equipment to your vehicle. These procedures should not be attempted by "do-it-yourselfers."

1. Disconnect the negative (-) cable from the battery first.
2. Allow the engine and all cooling system components to cool down.
3. Open the hood. Remove the five clips, one retaining tab and one pin, and remove the left front fender trim.

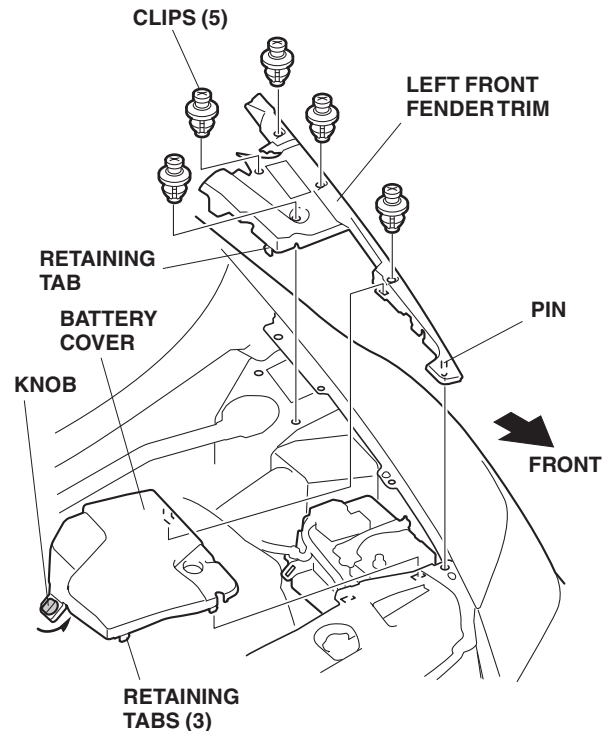

4. Turn the knob and remove the three retaining tabs, and remove the battery cover.

- Remove the two top clips (long) and four top clips (short) from the grille cover. Then pull up the front end of the right front fender trim and release the pin from the hole in right side of the grille cover and remove the grille cover (one clip, four retaining tabs).

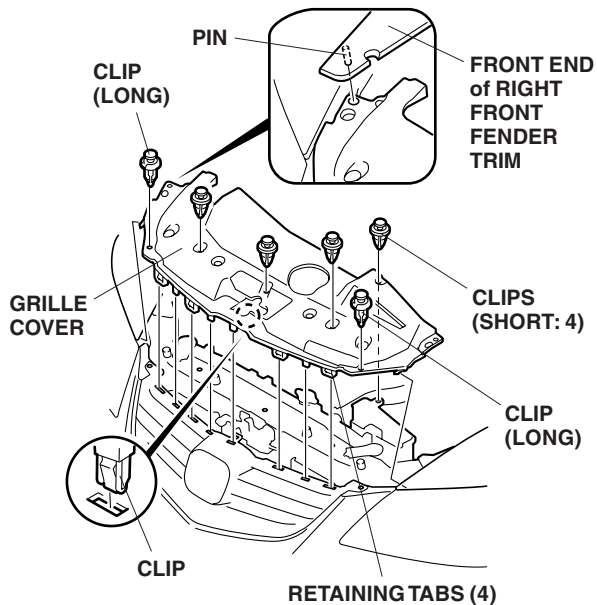

- Open the battery fuse box cover and disconnect the positive (+) battery cable from the battery. Unfasten the two battery holder nuts and remove the battery holder, then remove the battery.

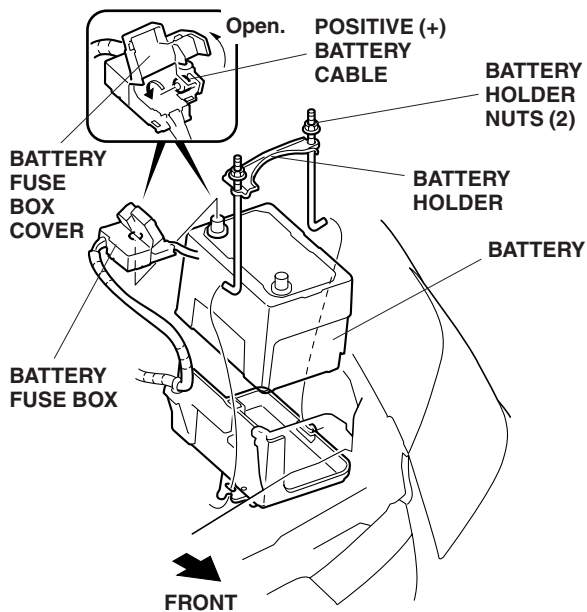

- Remove the two clips, then remove the front grille by pull up the four retaining tabs and pulling it out toward you.

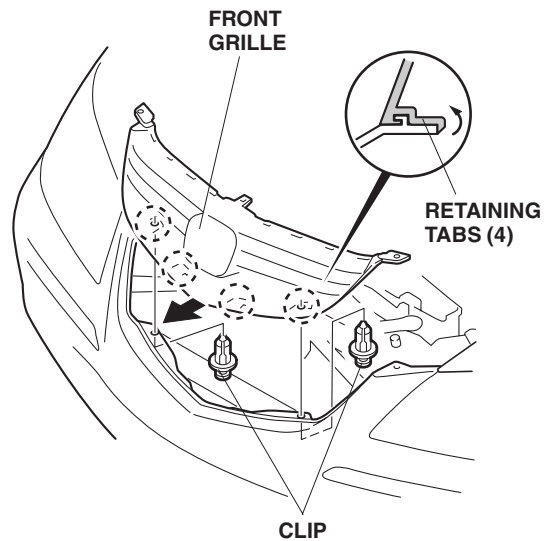

- Place a clean drain pan under the radiator drain plug, then remove the drain plug from the bottom of the radiator to drain the coolant. Remove the radiator cap to increase the flow.

NOTICE Radiator coolant will damage paint. Quickly rinse any spilled coolant from painted surfaces.

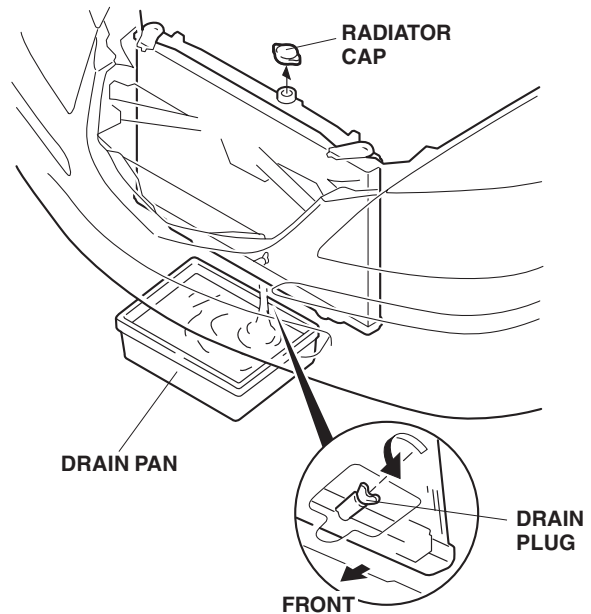

- On the front side of the engine, locate and remove the engine block drain bolt and washer. Coolant remaining in the engine jackets will flow out of the bolt hole when the bolt is removed. (Retain the drain bolt in case the engine block heater is removed.)

DRAIN BOLT
(Retain.)

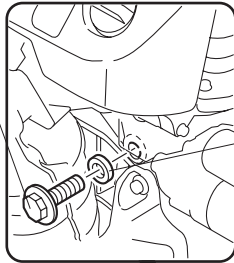

WASHER
(Discard.)

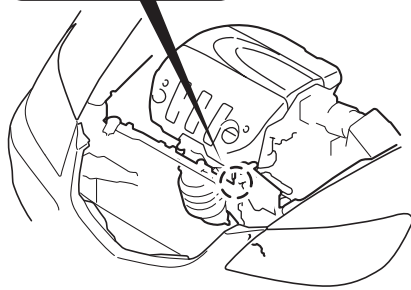

- Install the new aluminium washer and the engine block heater into the bolt hole using a 24 mm socket and a torque wrench. Torque the engine block heater to 60 N·m (44 lb-ft).

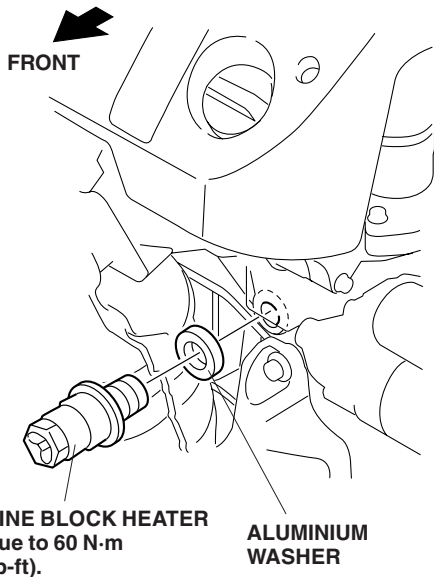

- Using a marker and a tape measure, measure and mark the heater harness at the measurement shown.

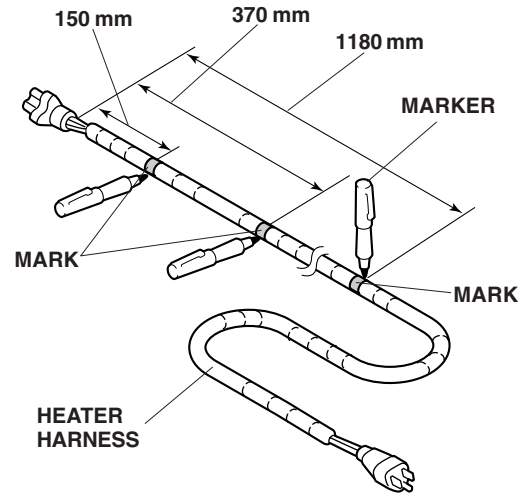

- Plug the connector end of the heater harness into the engine block heater. Then route the heater harness and secure it to the vehicle bracket with one wire tie at the mark made in step 11.

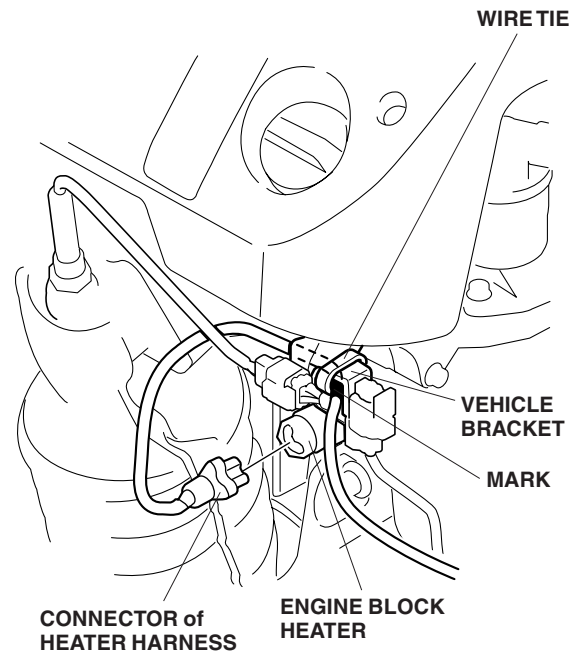

13. Remove the vehicle harness (four tabs) and one clip from the intake duct. Then pull up and release the hook to remove the intake duct.

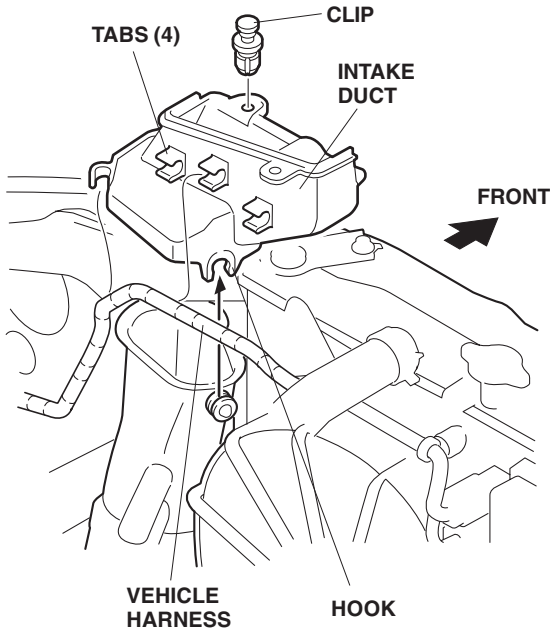

14. Route the heater harness and secure it to the vehicle harness with one wire tie at the mark made in step 11. Continue routing the heater harness along the vehicle harness and secure it to the vehicle harness with four wire ties as shown.

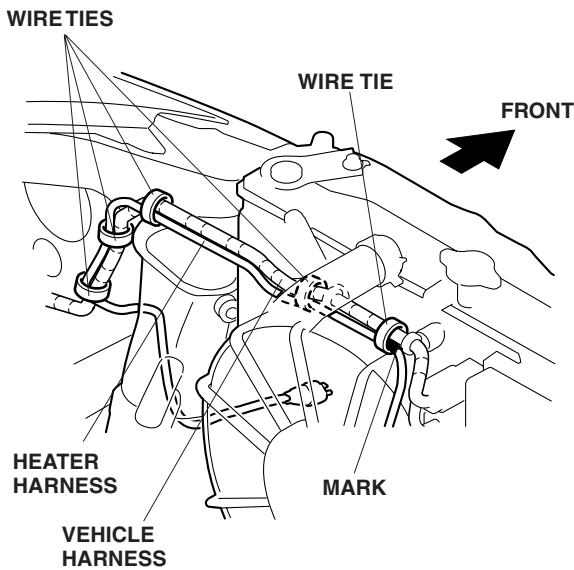

15. Reinstall the intake duct.

16. Continue routing the heater harness to the front side of vehicle, and attach the one wire tie with clip to the mark made in step 11 on the heater harness. Then push its clip into the hole in the bracket on the ATF cooler as shown.

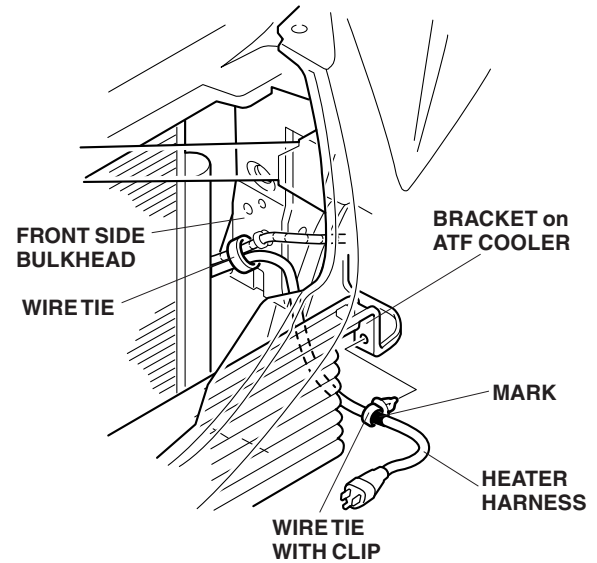

- Perform the work by inserting your hands through the front grille opening.

17. Then secure the heater harness to the vehicle harness with one wire tie as shown.

18. Continue routing the heater harness to the right side of the bumper lower grille on the back side of the front bumper as shown. Attach the heater harness to the bumper lower grille with three wire ties.

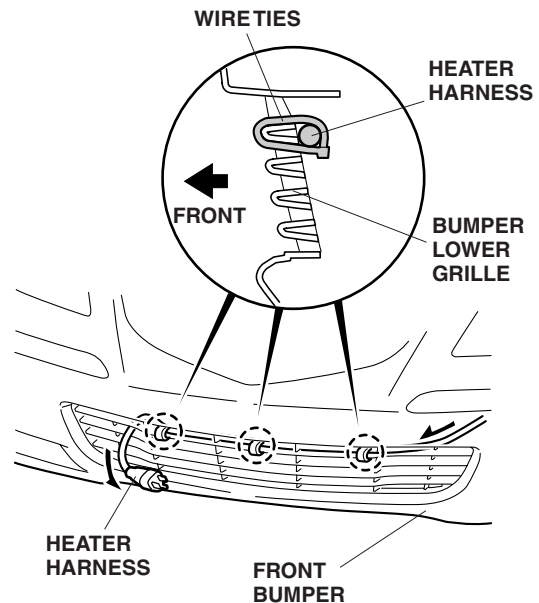

19. Attach the protective cap to the front bumper lower grille, and plug the connector of the heater harness into the protective cap.

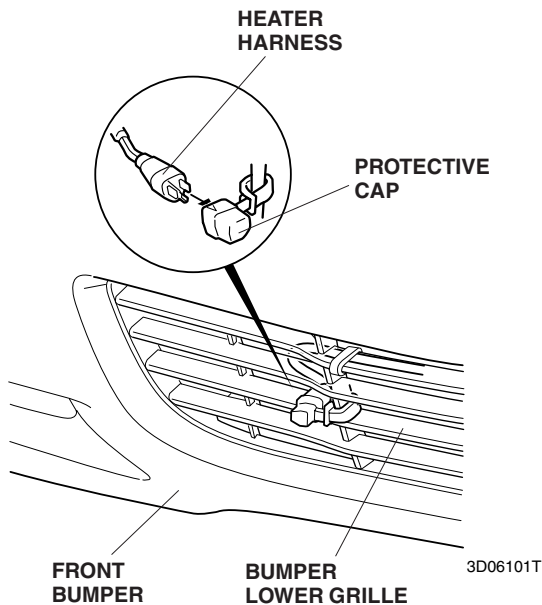

20. Reinstall the radiator drain plug.
21. Fill the system with the recommended coolant. Follow the instructions described in the service manual.
22. Check the coolant reservoir for correct level and signs of leakage. Repair as necessary.
23. Check that the heater harness is routed properly and all connectors are plugged in.
24. Put the drain bolt (removed in step 9) in the glove box.
25. Reinstall all removed parts.
26. Reinstall the battery.
27. Enter the anti-theft codes for the radio and navigation system, then enter the customer's radio presets.
28. Reset the clock.

NOTE: Whenever the battery is disconnected, the driver's window AUTO function is disabled.

29. Start the engine. Push down on the driver's window switch until the window is fully open.
30. Pull up on the driver's window switch to close the window completely, then hold the switch for 2 seconds or more.
31. Lower and raise the driver's window to check the operation of the driver's window AUTO function.
32. Do the PCM idle learn procedure.
 - Make sure all electrical items are turned off.
 - Start the engine. Hold the engine speed at 3,000 rpm with no load (in Park or Neutral) until the radiator fan comes on.
 - Let the engine idle for about 10 minutes with the throttle fully closed and with all electrical items off.

NOTE: If the radiator fan comes on during this step, the time it is operating must not be included in the 10 minutes.