

Accessory	Application	Publications No.
<b>FULL NOSE MASK</b>	<b>2007 TSX</b>	<b>BII 33671</b>
		Issue Date
		<b>SEP 2006</b>

**Put this information in the glove box with the vehicle owner's manual**

**PARTS LIST**

Mask  
(bumper section)

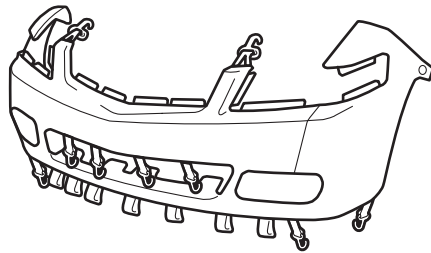

Mask  
(hood section)

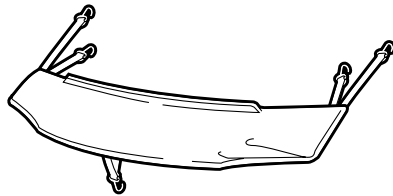

2 Snap-screws



2 Washers



2 Fenderwell nuts



Elastic cord

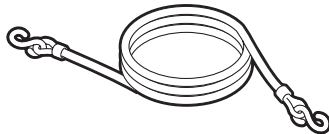

Storage bag

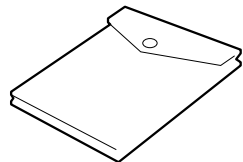

**TOOLS REQUIRED**

Stubby #2 Phillips screwdriver

Clip remover

Scissors

**INSTALLATION**

**NOTE:**

- Make sure the vehicle and the nose mask are clean and completely dry before installation. If moisture under the mask is allowed to dry, it may cloud the paint. If the mask gets wet, remove it and allow it to air-dry completely.
- Make sure any repainted surfaces are cured.
- Make sure the hood and nose of the vehicle have been waxed with a high-quality paste wax.
- Make sure you install the nose mask securely. If the nose mask starts to flap or comes loose while driving, safely pull off the highway, stop the vehicle, and secure or remove the mask.

**Displaying the Front License Plate**

If your state law requires the display of both license plates, cut out the piece of the bumper section that covers the front license plate:

- Face the inside of the mask toward you.
- Carefully cut out the license plate section with scissors at the top seam, and remove the overcast stitching.

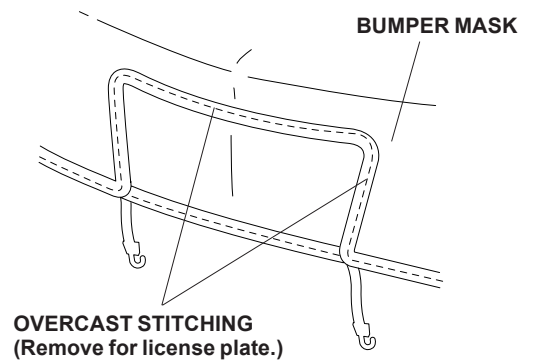

## Installing the Hood Section

1. Open the hood, remove the two hood insulator clips. (Save the insulator clips for your customer; they can be reinstalled if the mask is removed.)

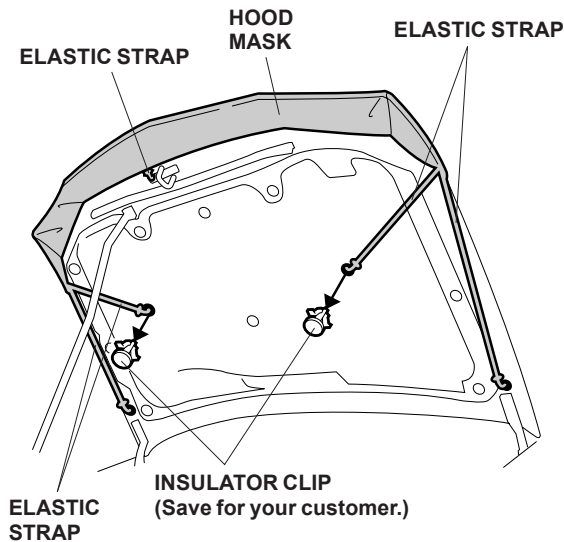

2. Fit the corners of the mask around the hood, and adjust the mask so that it fits smoothly over the edges. Attach the center elastic strap to the oval hole in the hood lock. Attach the other four elastic straps to the inner holes of the hood in the areas shown.

## Installing the Bumper Section

3. Turn the steering wheel all the way clockwise.
4. Pry out the plastic pin, and remove the expansion clip that fastens the inner fender; retain the pin and the clip, then clean the area around the hole.

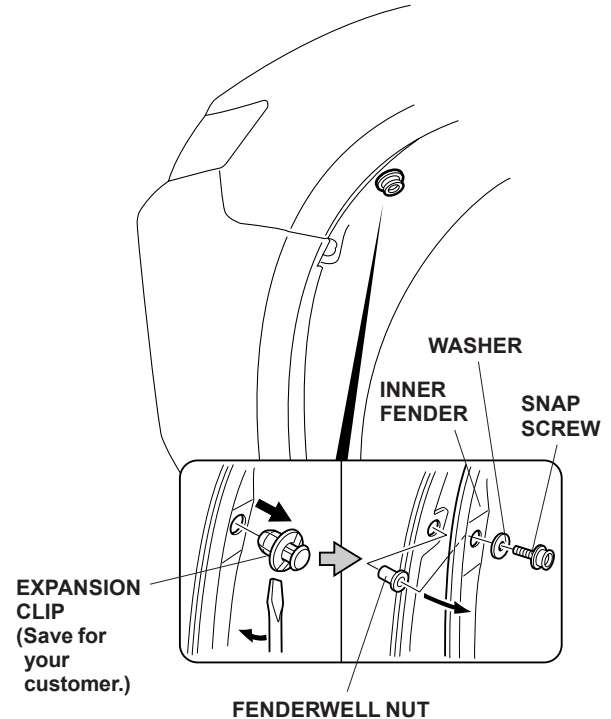

5. Pull the inner fender away, and press one fenderwell nut (supplied) into the hole in the fender flange.
6. With its washer in place, securely tighten one snap-screw into the fenderwell nut.
7. Turn the steering wheel all the way counterclockwise, and repeat steps 4 thru 6 on the other side of the vehicle.

- Slip the pocket of the mask's fender section onto the front corner of the fender; then attach the plastic hook to the top inside edge of the fender. Fit the mask across the bumper, and attach the mask to the other side the same way.

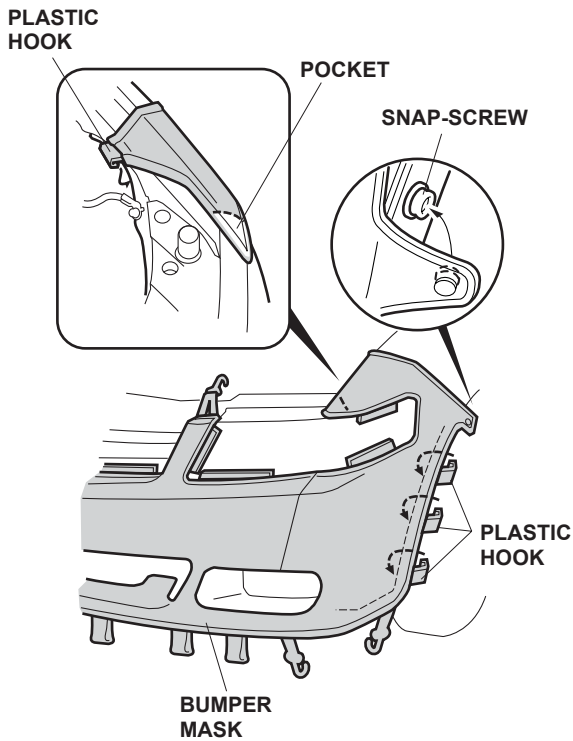

- Pull the mask back toward the wheelwell, smooth out any wrinkles, and snap the mask onto the snap-screw. Repeat on the other side.
- On each side of the vehicle, attach the three plastic hooks to the fenderwell.

- On each side of the vehicle, insert one tab between the headlight and the fender, and insert three tabs between the headlight and the front bumper.

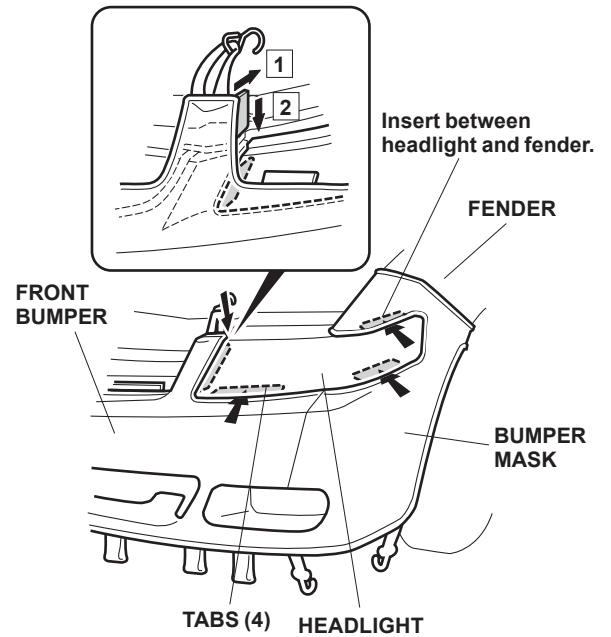

- Attach the four tabs to the inside of the front grille, and attach the two elastic straps to the radiator cover.

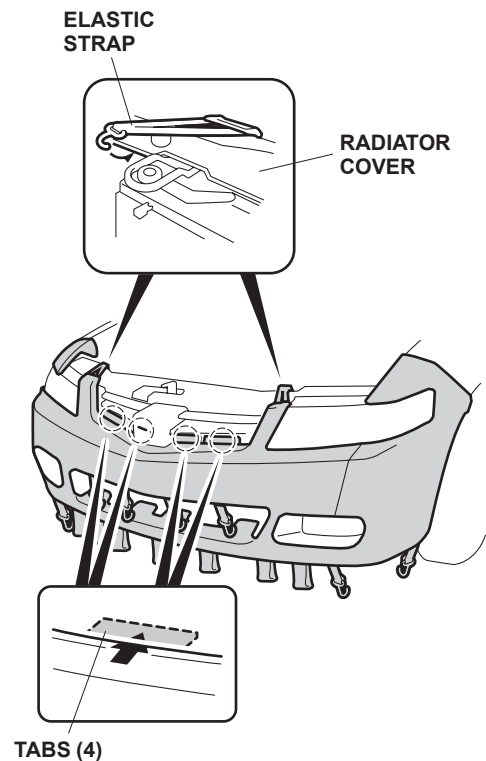

- Attach the four elastic straps to the inside top edge of the grille opening, and attach the four plastic hooks to the bottom inside edge of the grille opening. On each side, attach the two outboard straps to the bottom of the bumper.

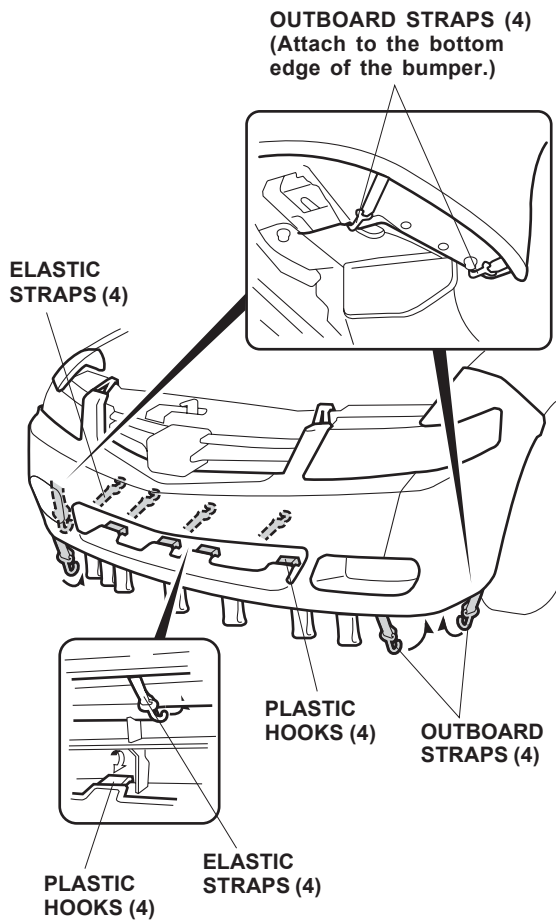

- Route the elastic cord through the loops on the bottom of the mask, and attach the "S" hooks at the ends of the elastic cord to the holes in the bumper on both sides.

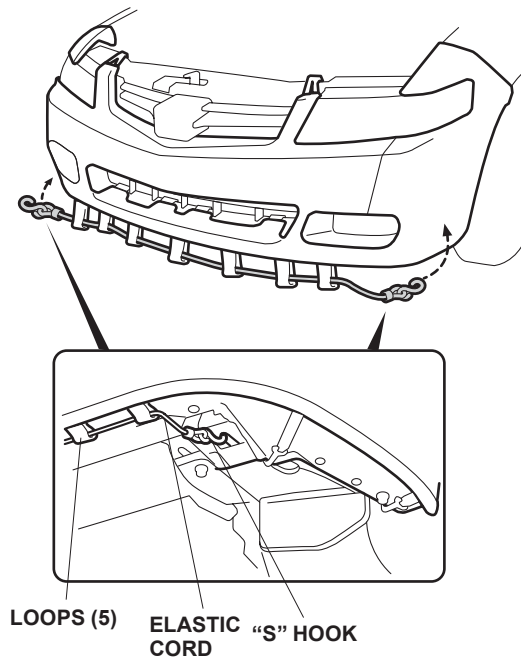

- Put these instructions, along with the clips (removed in step 1), plastic pins and expansion clips (removed in step 4) into the storage bag, and place it in the trunk for future use.

### CLEANING THE NOSE MASK

Use a sponge or cloth and a solution of mild liquid dishwashing soap and water to clean the vinyl and the flannel backing. Rinse the mask completely with clean water, and hang it to dry, out of direct sunlight. Make sure the mask is completely dry before you reinstall it.