



ACURA INSTALLATION INSTRUCTIONS

Accessory

MOONROOF VISOR
P/N 08R01-SEC-200

Application

2006 TSX

Publications No.

BII 31337

Issue Date

OCT 2005

Put this information in the glove box with the vehicle owner's manual.

PARTS LIST

Moonroof visor

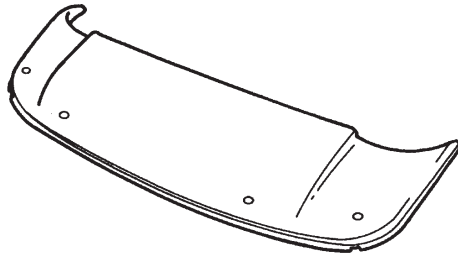

2 Front brackets (long)

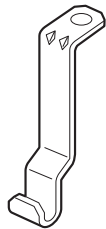

2 Side brackets (short)



4 Screws



4 Nuts



4 Protective tapes



TOOLS AND SUPPLIES REQUIRED

Phillips screwdriver

10 mm Combination wrench

Straightedge

Isopropyl alcohol

Shop towel

Masking tape

Felt-tip pen

INSTALLATION

1. Clean the roof area to be covered, and wax the area with a high-quality paste wax.
2. Open the moonroof.
3. On the inside of the moonroof opening, locate the center indentation. To the right and left of the center indentation, locate the third indentation on each side of the moonroof opening.

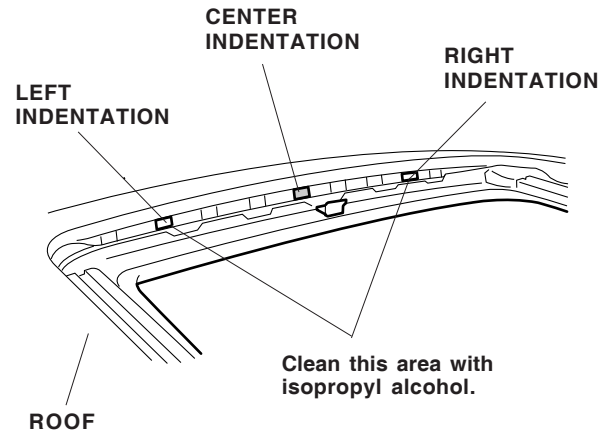

4. Using isopropyl alcohol on a shop towel, clean the roof in front of the right and left indentation as well as the center of each of the two indentations.

- Remove the adhesive backing from one protective tape. Starting at the bottom edge of the tape, wrap 6 mm of the protective tape around the lip of the moonroof opening to cover one of the located indentations; continue upward with the tape around the top of the roof panel. Using the same procedure, attach the other protective tape to the roof at the other located indentation.

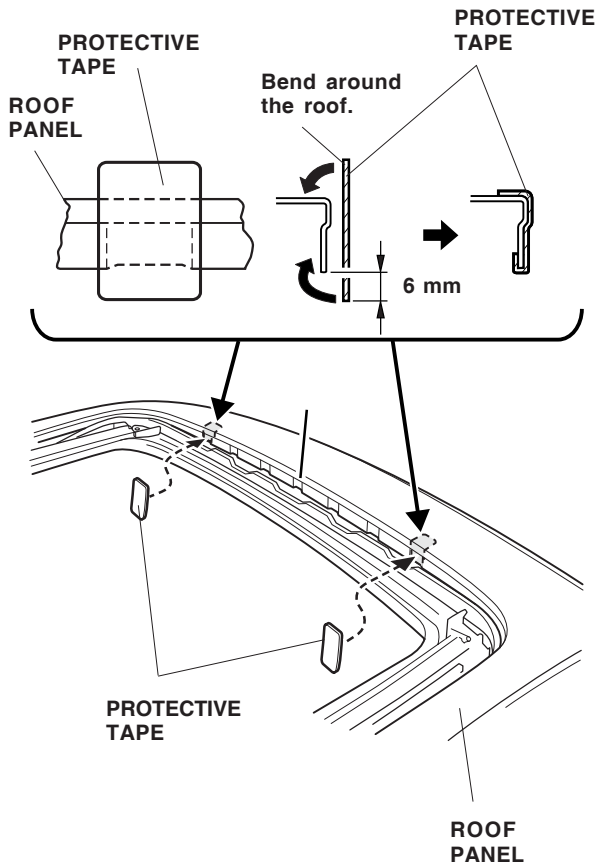

- At the left front corner of the moonroof opening, locate the front moon roof guide rail screw. From the guide rail screw, place a straightedge directly outboard from the screw as shown, and mark the edge of the roof with a felt-tip pen.

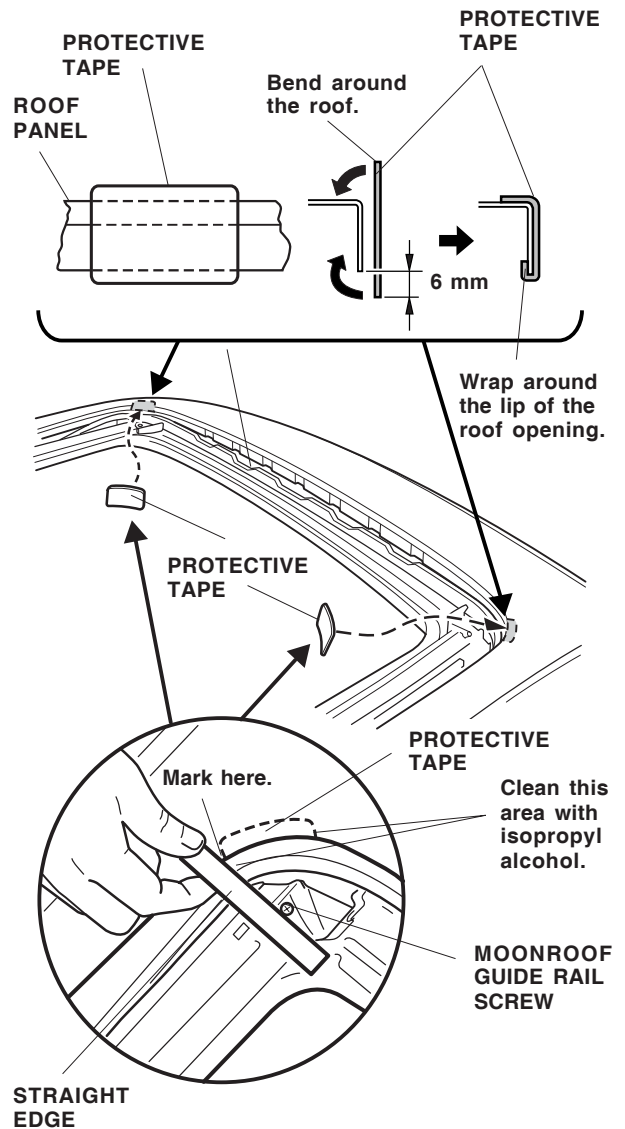

- Using isopropyl alcohol on a shop towel, clean the roof area and the inside edge of the moonroof opening from the mark forward about 2 in.
- Remove the adhesive backing from one protective tape. Starting at the bottom edge, wrap 6 mm of protective tape around the lip of the moonroof opening just in front of the mark; continue upward with the tape around the top of the roof panel.
- Repeat steps 6 thru 8 to install the protective tape on the right side of the moonroof opening. Remove the marks you made using isopropyl alcohol on a shop towel.

- Place the two front brackets into position over the protective tapes and around the lip of the roof opening. Tape the front brackets into position with a piece of masking tape. Place the two side brackets into position over the protective tape and around the lip of the roof opening, and tape them into position with a piece of masking tape.
- Set the moonroof visor on the vehicle roof in front of the moonroof opening, and adjust its position so the holes in the visor are aligned with the front bracket holes. Install two screws and nuts loosely onto the front brackets A.

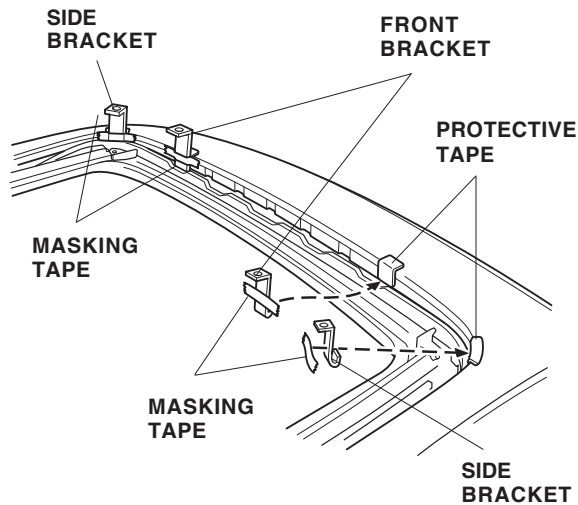

- Line up the side bracket B holes with the visor holes, and loosely install the two screws and nuts.

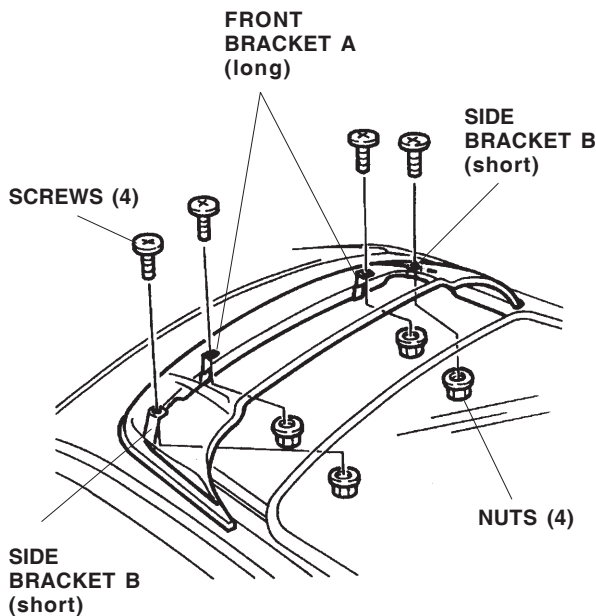

- Position the moonroof visor with equal spacing on all sides. Check that the rubber seal is not twisted or rolled under the visor.

- Tighten the nuts and screws, alternating between sides. To prevent damage to the moonroof visor and the resin nuts, do not overtighten the screws.

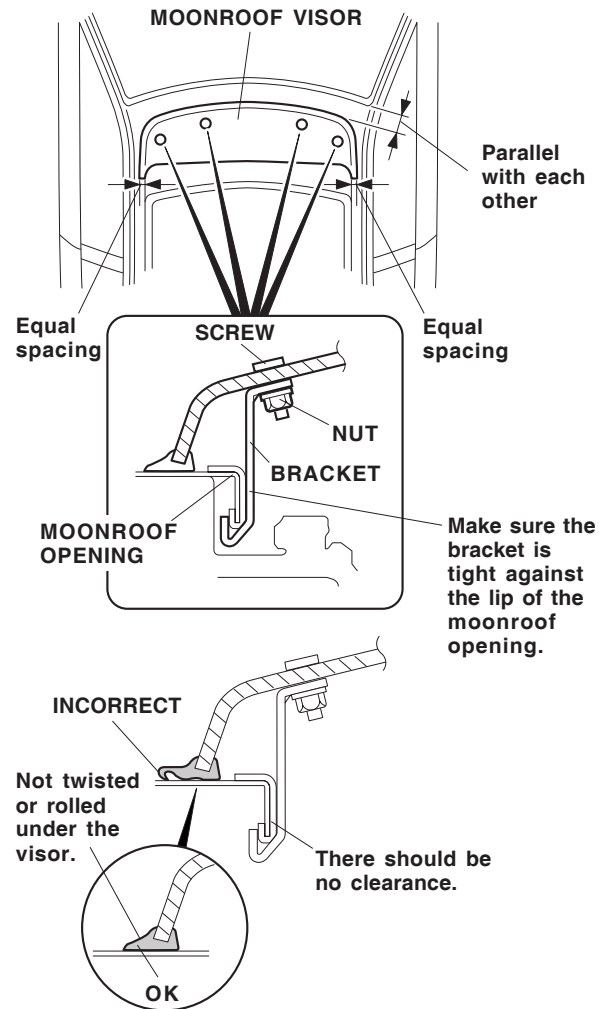

CARE OF THE MOONROOF VISOR

- To avoid damaging the surface, never use ammonia-based cleaners or solvents to clean the moonroof visor.
- Clean with a solution of mild dishwashing soap and water using a soft cloth or chamois.
- To remove fine scratches and restore the original luster, use Meguiar's Mirror Glaze plastic cleaner and polish or an equivalent high-quality plastic cleaner.