

ACURA INSTALLATION INSTRUCTIONS

Accessory

**GOLD EMBLEM
P/N 08F20-SEC-200**

Application

2006 TSX

Publications No.

BII 31330

Issue Date

OCT 2005

PARTS LIST

Front "A" emblem

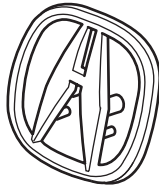

Rear "A" emblem



Rear "TSX" emblem

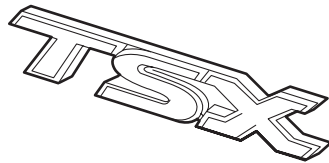

Rear "ACURA" emblem

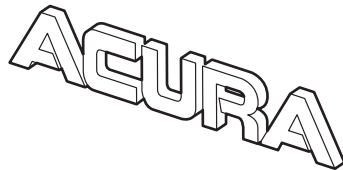

TOOLS AND SUPPLIES REQUIRED

Phillips screwdriver
Flat-tip screwdriver
Clip remover
Diagonal cutters
Isopropyl alcohol
Shop towel
String
Masking tape
Long-nose pliers

INSTALLATION

NOTE:

- Be careful not to damage the body paint finish when removing and installing the emblems.
- This gold emblem kit should only be installed if the ambient air temperature is 60°F (15°C) or above.
- To allow the adhesive to cure, do not wash the car for 24 hours.

Installing the Front "A" Emblem

1. Open the engine hood. Remove the eight short clips, two long clips, and two medium clips securing the radiator cover and remove the cover.

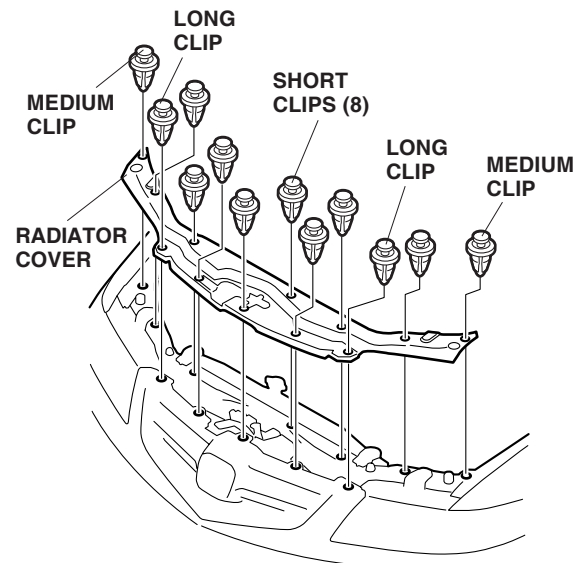

- Using a small Phillips screwdriver, reach between the radiator bulkhead and front grille.
- Remove the two self-tapping screws securing the old "A" emblem, and remove the emblem.

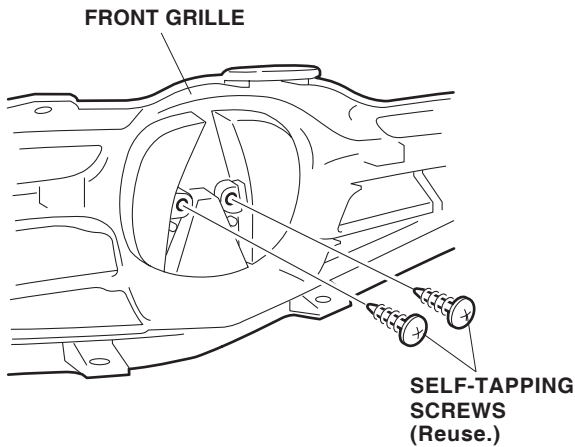

- Slide the pins on the gold "A" emblem into the holes in the front grille and install the two self-tapping screws you just removed.

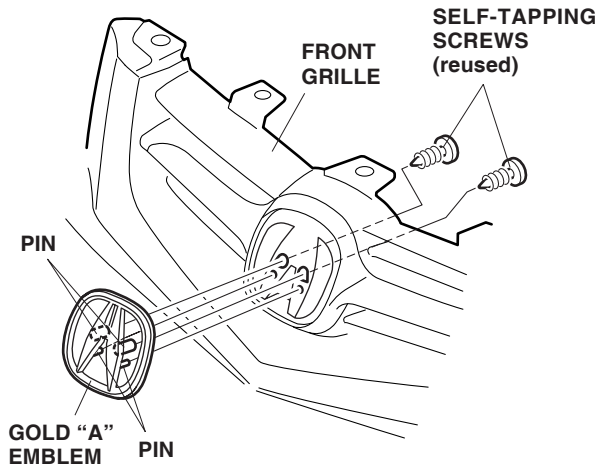

- Reinstall the radiator cover in the reverse order of removal. Check that the clips and other fasteners are installed securely without play or lifting.

Installing the Rear "A," "ACURA," and "TSX" Emblems

- To prevent damage to the body paint finish and help you position the gold emblems, attach masking tape around the original rear "A," "ACURA," and "TSX" emblems.

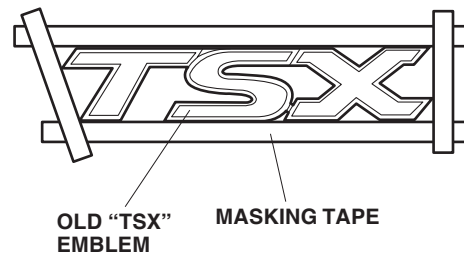
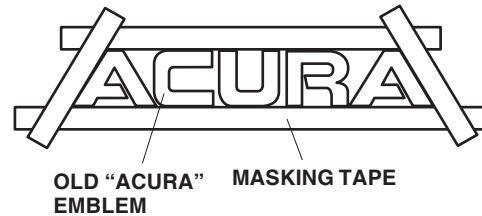
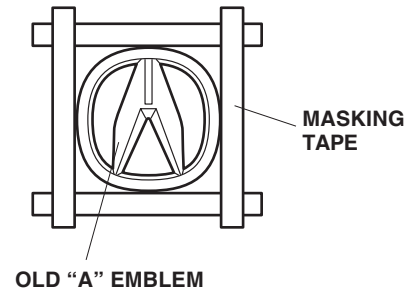

- Remove the original emblems by cutting the outer edges with a piece of string. Note the location of the retaining pins on the back of each original emblem when cutting the edges.
- Remove the original "A," "ACURA," and "TSX" emblems.

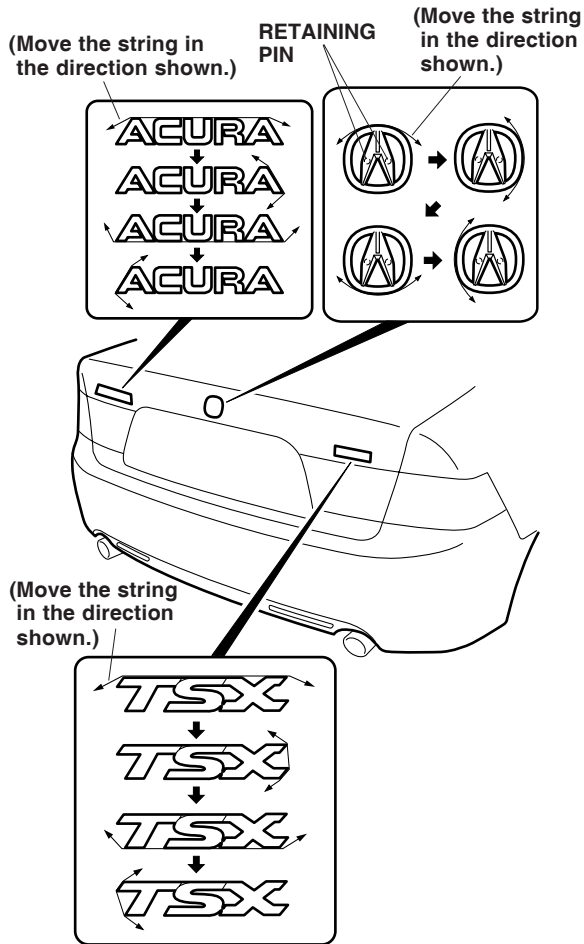

- If any clip(s) for the "A" emblem remain in the vehicle body panel, remove the clip(s) with long-nose pliers.

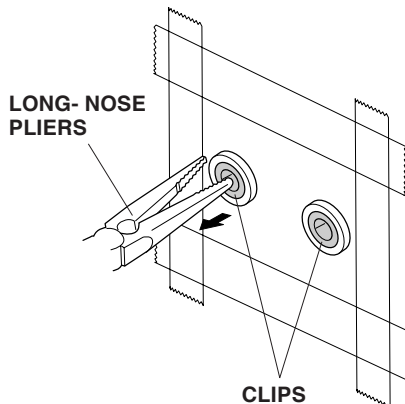

- Using isopropyl alcohol on a shop towel, clean the areas where the new gold emblems will attach.
- Remove the adhesive backings from the new rear "A," "ACURA," and "TSX" emblems. Align the retaining pins on the "A" emblem in the trunk lid, and "ACURA" and "TSX" emblems with the masking tape, and attach them to the trunk lid. Press the emblems firmly against the trunk lid with the palm of your hand for 30 seconds.

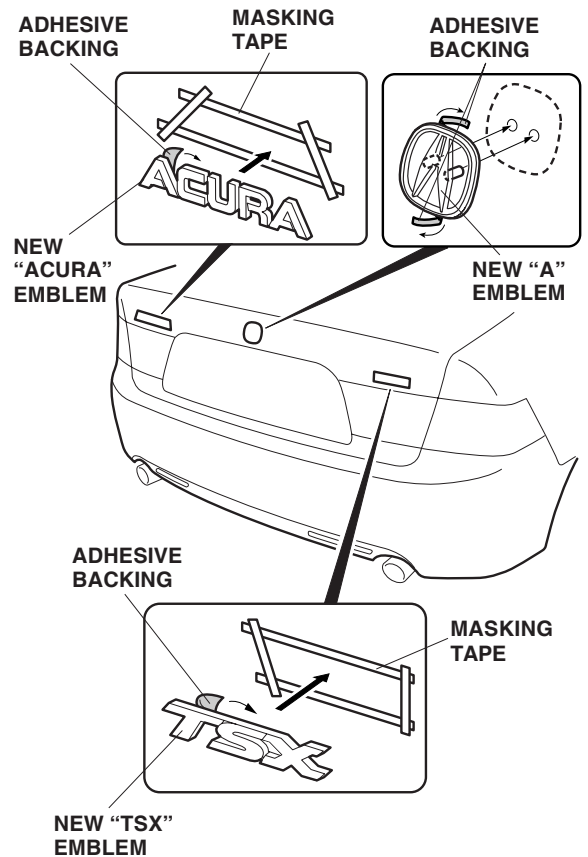

- Remove the masking tape.