



INSTALLATION INSTRUCTIONS

Accessory

ENGINE BLOCK HEATER
P/N 08T44-S5B-100

Application

2005 MDX

Publications No.

BII 28214

Issue Date

SEP 2004

PARTS LIST

Engine block heater



Aluminum washer



Heater harness

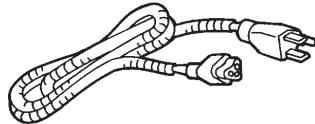

Protective cap

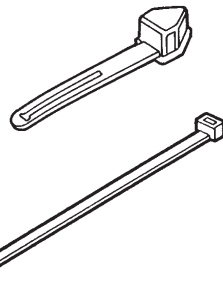

12 Short wire ties
(7 Not used)

TOOLS AND SUPPLIES REQUIRED

Ratchet

19 mm and 24 mm Sockets

Torque wrench

Diagonal cutters

Drain pan

Coolant (Antifreeze/Coolant Type 2 only, in a 50/50 mixture with water)

NOTE:

- Always use Acura Antifreeze/Coolant. Using a non-Acura coolant can result in corrosion, causing the cooling system to malfunction or fail.
- To avoid burning out the element, do not operate the engine block heater before it is installed in the vehicle and before you add coolant.

INSTALLATION

Customer Information: The information in this installation instruction is intended for use only by skilled technicians who have the proper tools, equipment, and training to correctly and safely add equipment to your vehicle. These procedures should not be attempted by "do-it-yourselfers."

1. Allow the engine and all cooling system components to cool down.
2. Place a clean drain pan under the radiator drain plug, then remove the drain plug from the bottom of the radiator to drain the coolant. Remove the radiator cap to increase the flow.

NOTICE Radiator coolant will damage paint. Quickly rinse any spilled coolant from painted surfaces.

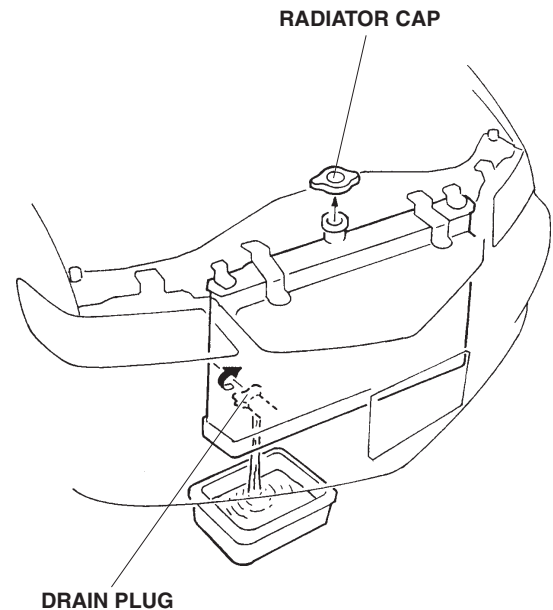

3. Locate and remove the engine block drain bolt and washer. Coolant remaining in the engine jackets flows out of the bolt hole when the bolt is removed. (Retain the bolt and washer in case the block heater is removed.)

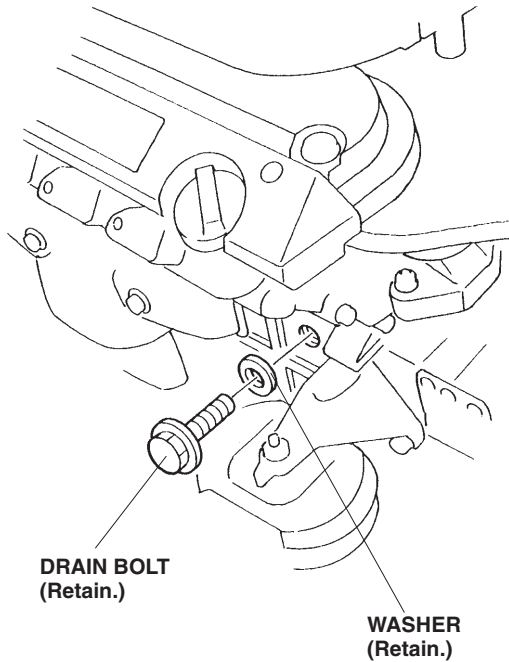

4. Install the new aluminum washer and the engine block heater into the bolt hole using a 24 mm socket and a torque wrench. Torque the engine block heater to 60 N·m (44 lb-ft).

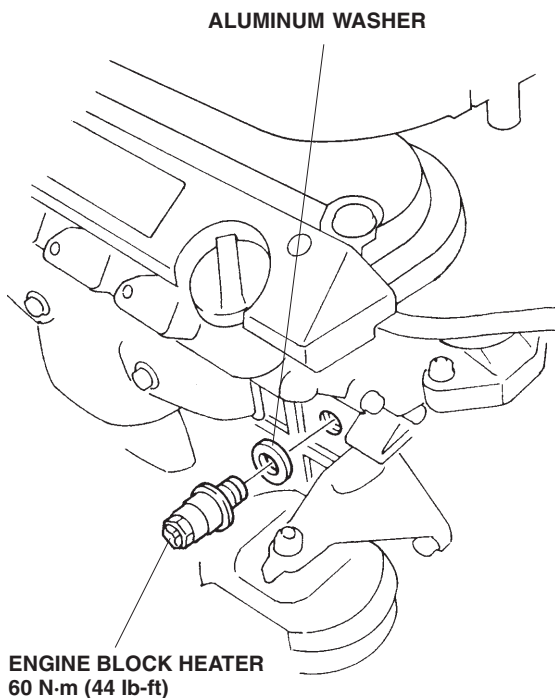

5. Using a tape measure, measure and mark the heater harness at the measurements shown.

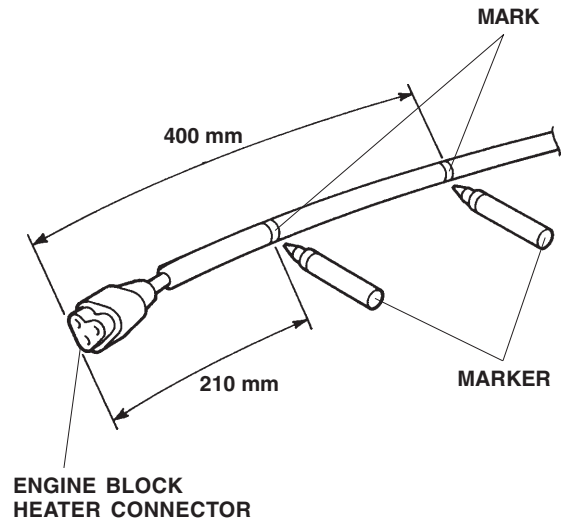

6. Plug the connector end of the heater harness into the engine block heater, then route the heater harness so that the marks you just made on the heater harness are positioned equally on both sides of the radiator cooling fan. Secure the heater harness to the fan shroud with the two wire ties in the areas shown.

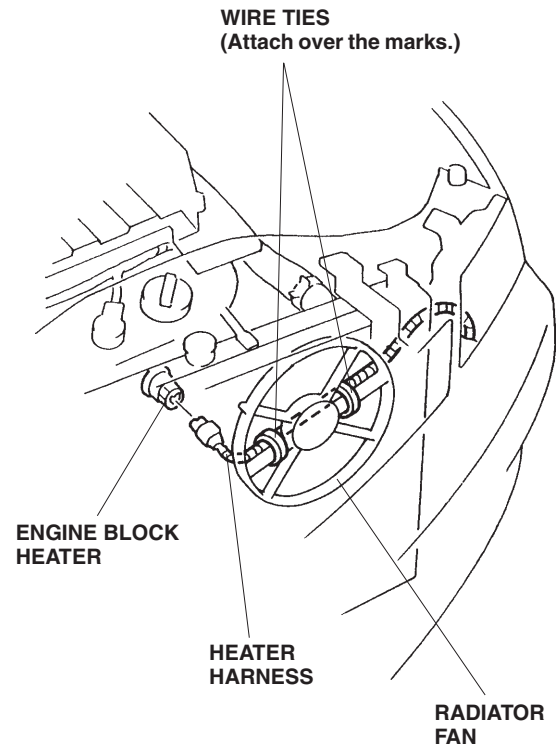

7. Continue routing the heater harness toward the front through the hole in the body, below the headlight.

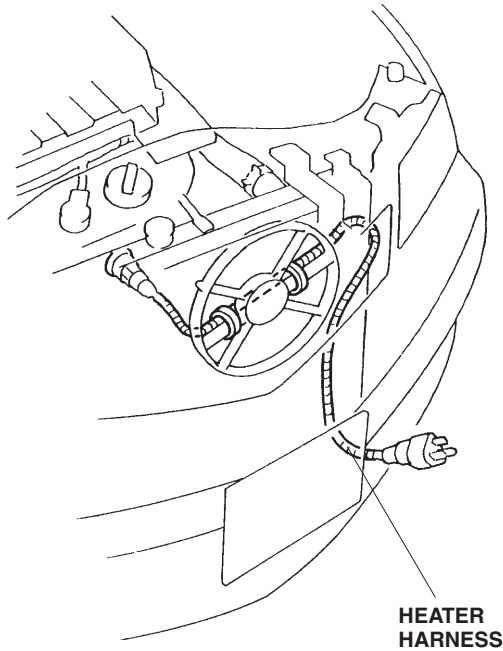

8. Attach the protective cap to the front grille, and plug the connector of the heater harness into the protective cap.

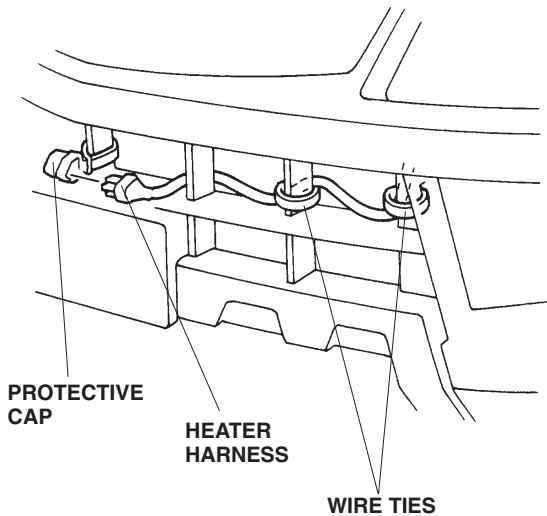

9. Secure the heater harness to the bumper with two wire ties.

10. Reinstall the radiator drain plug.
11. Fill the system with the recommended coolant. Follow the instructions described in the service manual.
12. Check the coolant reservoir for correct level and signs of leakage. Repair as necessary.
13. Check that the heater harness is routed properly and all connectors are plugged in.
14. Put the drain bolt (removed in step 3) in the glove box.